

MANDRINI PORTA UTENSILI HSK DIN 69893



HSK DIN 69893 TOOL HOLDERS
WERKZEUGAUFNAHMEN HSK DIN 69893

PORTE-OUTILS HSK DIN 69893
PORTAHERRAMIENTAS HSK DIN 69893



Equilibratura: G 2,5 fino a 20.000 giri/minuto.

Balanced to G 2,5 at 20.000 rpm.

Gewuchtet nach G 2,5 bei 20.000 U/min.

Équilibré G 2,5 jusqu'à 20.000 tours/min.

Equilibrado G 2,5 hasta 20.000 rpm.

PORTAPINZA A GRANDE CAPACITA' DI SERRAGGIO PER PINZE DIN 6499

COLLET CHUCK FOR DIN 6499 COLLETS

SPANNZANGENFUTTER DIN 6499

PORTE PINCES POUR PINCES DIN 6499

PORTA PINZAS DIN 6499

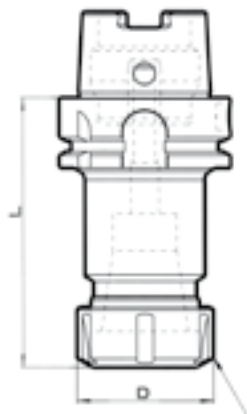

HSK - A+C

CODICE CODE BESTELL NR CODE CÓDIGO	ATTACCO SHANK AUFNAHMEN ATTACHEMENT MANGO	D	L	Pinze ER ER Collets Zangen ER Pinces ER Pinzas ER
* 1218.16.H32A	HSK-32A	22	80	16
* 1218.16.H40A	HSK-40A	22	80	16
• 1198.25.H40AN	HSK-40A	42	80	25
• 1198.32.H40AN	HSK-40A	50	100	32
* 1218.16.H50A	HSK-50A	22	100	16
• 1198.25.H50AN	HSK-50A	42	100	25
• 1198.32.H50AN	HSK-50A	50	100	32
* 1218.16.H63A	HSK-63A	22	100	16
1198.25.H63AN	HSK-63A	42	100	25
1198.32.H63AN	HSK-63A	50	100	32
1198.40.H63AN	HSK-63A	63	120	40
* 1218.16.H100A	HSK-100A	22	160	16
1198.32.H100AN	HSK-100A	50	100	32
1198.40.H100AN	HSK-100A	63	120	40
Prolungati Extended Verlängerte Prolongé Extendido				
* 2218.16.H40A	HSK-40A	22	120	16
• 2198.25.H40AN	HSK-40A	42	120	25
* 2218.16.H63A	HSK-63A	22	160	16
* 3218.16.H63A	HSK-63A	22	200	16
2198.25.H63AN	HSK-63A	42	160	25
2198.32.H63AN	HSK-63A	50	160	32
2198.40.H63AN	HSK-63A	63	160	40
2198.32.H100AN	HSK-100A	50	160	32
2198.40.H100AN	HSK-100A	63	160	40

• Disponibile solo su richiesta
Available only on demand
Verfügbar nur auf Anfrage
Disponible seulement sur demande
Disponibles bajo petición

Per utensili a gambo cilindrico

For cylindrical shank tools

Zur Aufnahme von Werkzeugen mit Zylinderschaft in Spannzangen.

Pour outils avec queue cylindrique.

Para herramientas de mango cilíndrico

* Forniti con ghiera mini cod. 9131.16.22

Supplied with mini nut code 9131.16.22

Lieferumfang komplett mit Minimutter 9131.16.22

Fourni avec bague mini 9131.16.22

Entregado con tuerca mini 9131.16.22

PORTAPINZA A GRANDE CAPACITA' DI SERRAGGIO PER PINZE DIN 6499

COLLET CHUCK FOR DIN 6499 COLLETS
SPANNZANGENFUTTER DIN 6499
PORTE PINCES POUR PINCES DIN 6499
PORTA PINZAS DIN 6499

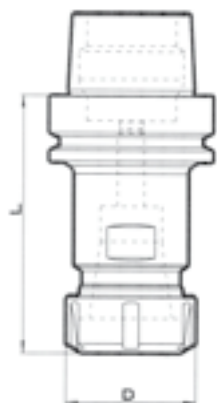

HSK - E

CODICE CODE BESTELL NR CODE CÓDIGO	ATTACCO SHANK AUFNAHMEN ATTACHEMENT MANGO	D	L	Pinze ER ER Collets Zangen ER Pinces ER Pinzas ER
* 1218.16.H40E	HSK-40E	22	80	16
• 1198.25.H40EN	HSK-40E	42	80	25
• 1198.32.H40EN	HSK-40E	50	100	32
* 1218.16.H50E	HSK-50E	22	100	16
• 1198.25.H50EN	HSK-50E	42	100	25
• 1198.32.H50EN	HSK-50E	50	100	32
* 1218.16.H63E	HSK-63E	22	160	16
• 1198.25.H63EN	HSK-63E	42	100	25
• 1198.32.H63EN	HSK-63E	50	100	32
• 1198.40.H63EN	HSK-63E	63	120	40
Prolungati Extended Verlängerte Prolongé Extendido				
* 2218.16.H40E	HSK-40E	22	120	16
* 2218.16.H63E	HSK-63E	22	160	16
• 2198.25.H40EN	HSK-40E	42	120	25
• 2198.25.H63EN	HSK-63E	42	160	25
• 2198.32.H63EN	HSK-63E	50	160	32
• 2198.40.H63EN	HSK-63E	63	160	40

• Disponibile solo su richiesta
Available only on demand
Verfügbar nur auf Anfrage
Disponible seulement sur demande
Disponibles bajo petición

Per utensili a gambo cilindrico

For cylindrical shank tools

Zur Aufnahme von Werkzeugen mit Zylinderschaft in Spannzangen.

Pour outils avec queue cylindrique.

Para herramientas de mango cilíndrico

* Forniti con ghiera mini cod. 9131.16.22

Supplied with mini nut code 9131.16.22

Lieferbar zusammen mit Mini mutter 9131.16.22

Fourni avec bague mini 9131.16.22

Entregado con tuerca mini 9131.16.22

PORTAFRESA A TRASCINAMENTO FISSO

UNIVERSAL MILLING CUTTER HOLDER
 AUFSTECKFRAESERDORNE
 PORTE FRAISE ENTRAINEMENT FIXE
 PORTA FRESAS UNIVERSAL

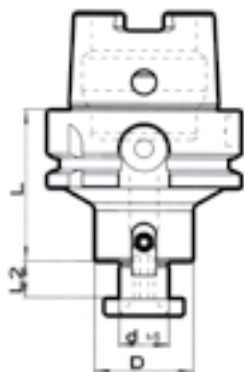

HSK - A+C

CODICE CODE BESTELL NR CODE CÓDIGO	ATTACCO SHANK AUFNAHMEN ATTACHEMENT MANGO	d	D	L2	L
• 1118.16.H40A	HSK-40A	16	35	17	45
• 1118.22.H40A	HSK-40A	22	50	19	50
• 1118.27.H40A	HSK-40A	27	60	21	55
• 1118.16.H50A	HSK-50A	16	35	17	55
• 1118.22.H50A	HSK-50A	22	50	19	60
• 1118.27.H50A	HSK-50A	27	60	21	60
1118.16.H63A	HSK-63A	16	35	17	50
1118.22.H63A	HSK-63A	22	50	19	50
1118.27.H63A	HSK-63A	27	60	21	60
1118.32.H63A	HSK-63A	32	78	24	60
1118.40.H63A	HSK-63A	40	89	27	60
1118.22.H100A	HSK-100A	22	50	19	50
1118.27.H100A	HSK-100A	27	60	21	50
1118.32.H100A	HSK-100A	32	78	24	50
1118.40.H100A	HSK-100A	40	89	27	60

• Disponibile solo su richiesta
Available only on demand
 Verfügbar nur auf Anfrage
Disponible seulement sur demande
 Disponibles bajo petición

A richiesta combinato.

Kombi on request.

Auf Anfrage Kombi Ausführung.

Sur demande à double usage.

Combinado bajo pedido.

ATTACCO PER FRESE TIPO WELDON DIN 1835

WELDON SHANK
WELDON AUFNAHMEN
MANDRIN POUR OUTILS TYPE WELDON
MANGO WELDON

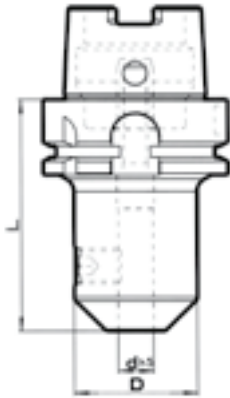

HSK - A+C

CODICE CODE BESTELL NR CODE CÓDIGO	ATTACCO SHANK AUFNAHMEN ATTACHEMENT MANGO	d	D	L
• 1248.06.H32A	HSK-32A	6	25	60
• 1248.08.H32A	HSK-32A	8	28	60
• 1248.10.H32A	HSK-32A	10	35	65
• 1248.06.H40A	HSK-40A	6	25	60
• 1248.08.H40A	HSK-40A	8	28	60
• 1248.10.H40A	HSK-40A	10	35	60
• 1248.12.H40A	HSK-40A	12	42	70
• 1248.14.H40A	HSK-40A	14	44	75
• 1248.16.H40A	HSK-40A	16	48	75
• 1248.20.H40A	HSK-40A	20	52	80
• 1248.06.H50A	HSK-50A	6	25	65
• 1248.08.H50A	HSK-50A	8	28	65
• 1248.10.H50A	HSK-50A	10	35	65
• 1248.12.H50A	HSK-50A	12	42	80
• 1248.14.H50A	HSK-50A	14	44	80
• 1248.16.H50A	HSK-50A	16	48	80
• 1248.18.H50A	HSK-50A	18	50	80
• 1248.20.H50A	HSK-50A	20	52	80
• 1248.25.H50A	HSK-50A	25	64	110
1248.06.H63A	HSK-63A	6	25	65
1248.08.H63A	HSK-63A	8	28	65
1248.10.H63A	HSK-63A	10	35	65
1248.12.H63A	HSK-63A	12	42	80

• Disponibile solo su richiesta
Available only on demand
Verfügbar nur auf Anfrage
Disponible seulement sur demande
Disponibles bajo petición

SEGUE
CONTINUE

For Weldon end mill with cylindrical shank DIN 1835
Zum Spannen von zylindrischen Werkzeugschäften nach DIN 1835
Pour fraises avec attachement cylindrique DIN 1835
Para fresa de mango cilíndrico con weldon DIN 1835

ATTACCO PER FRESE TIPO WELDON DIN 1835

WELDON SHANK
WELDON AUFNAHMEN
MANDRIN POUR OUTILS TYPE WELDON
MANGO WELDON

SEGUE
CONTINUE

HSK - A+C

CODICE CODE BESTELL NR CODE CÓDIGO	ATTACCO SHANK AUFNAHMEN ATTACHEMENT MANGO	d	D	L
1248.14.H63A	HSK-63A	14	44	80
1248.16.H63A	HSK-63A	16	48	80
1248.18.H63A	HSK-63A	18	50	80
1248.20.H63A	HSK-63A	20	52	80
1248.25.H63A	HSK-63A	25	64	110
1248.32.H63A	HSK-63A	32	64	110
1248.06.H100A	HSK-100A	6	25	80
1248.08.H100A	HSK-100A	8	28	80
1248.10.H100A	HSK-100A	10	35	80
1248.12.H100A	HSK-100A	12	42	80
1248.14.H100A	HSK-100A	14	44	80
1248.16.H100A	HSK-100A	16	48	100
1248.18.H100A	HSK-100A	18	48	100
1248.20.H100A	HSK-100A	20	52	100
1248.25.H100A	HSK-100A	25	64	100
1248.32.H100A	HSK-100A	32	72	100

ATTACCO PER FRESE TIPO WELDON DIN1835 PROLUNGATO

EXTENDED WELDON SHANK
WELDON AUFNAHMEN VERLÄNGERT
MANDRIN POUR OUTILS TYPE WELDON ALLONGÉ
MANGO WELDON EXTENDIDO

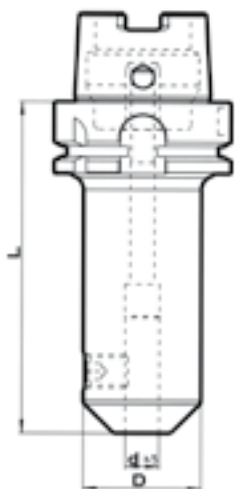

HSK - A+C

CODICE CODE BESTELL NR CODE CÓDIGO	ATTACCO SHANK AUFNAHMEN ATTACHEMENT MANGO	d	D	L
Prolungati Extended Verlängerte Prolongé Extendido				
2248.06.H63A	HSK-63A	6	25	100
2248.08.H63A	HSK-63A	8	28	100
2248.10.H63A	HSK-63A	10	35	100
2248.12.H63A	HSK-63A	12	42	120
2248.14.H63A	HSK-63A	14	44	120
2248.16.H63A	HSK-63A	16	48	120
2248.18.H63A	HSK-63A	18	50	120
2248.20.H63A	HSK-63A	20	52	120
2248.25.H63A	HSK-63A	25	64	150
2248.32.H63A	HSK-63A	32	72	150
2248.06.H100A	HSK-100A	6	25	120
2248.08.H100A	HSK-100A	8	28	120
2248.10.H100A	HSK-100A	10	35	120
2248.12.H100A	HSK-100A	12	42	120
2248.14.H100A	HSK-100A	14	44	120
2248.16.H100A	HSK-100A	16	48	150
2248.18.H100A	HSK-100A	18	50	120
2248.20.H100A	HSK-100A	20	52	150
2248.25.H100A	HSK-100A	25	64	150
2248.32.H100A	HSK-100A	32	72	150

For Weldon end mill with cylindrical shank DIN 1835
Zum Spannen von zylindrischen Werkzeugschaften nach DIN 1835
Pour fraises avec attachement cylindrique DIN 1835
Para fresa de mango cilíndrico con weldon DIN 1835

ATTACCO PER FRESE TIPO WELDON DIN 1835

WELDON SHANK
WELDON AUFNAHMEN
MANDRIN POUR OUTILS TYPE WELDON
MANGO WELDON

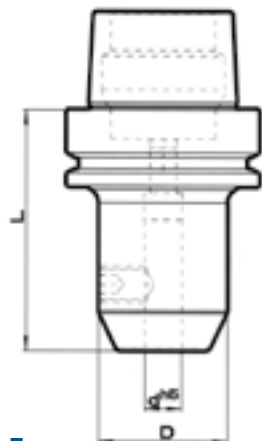

HSK - E

CODICE CODE BESTELL NR CODE CÓDIGO	ATTACCO SHANK AUFNAHMEN ATTACHEMENT MANGO	d	D	L
• 1248.06.H40E	HSK-40E	6	25	60
• 1248.08.H40E	HSK-40E	8	28	60
• 1248.10.H40E	HSK-40E	10	35	60
• 1248.12.H40E	HSK-40E	12	42	70
• 1248.14.H40E	HSK-40E	14	44	75
• 1248.16.H40E	HSK-40E	16	48	75
• 1248.20.H40E	HSK-40E	20	52	80
• 1248.06.H50E	HSK-50E	6	25	65
• 1248.08.H50E	HSK-50E	8	28	65
• 1248.10.H50E	HSK-50E	10	35	65
• 1248.12.H50E	HSK-50E	12	42	80
• 1248.14.H50E	HSK-50E	14	44	80
• 1248.16.H50E	HSK-50E	16	48	80
• 1248.20.H50E	HSK-50E	20	52	80
• 1248.25.H50E	HSK-50E	25	64	110
• 1248.06.H63E	HSK-63E	6	25	65
• 1248.08.H63E	HSK-63E	8	28	65
• 1248.10.H63E	HSK-63E	10	35	65
• 1248.12.H63E	HSK-63E	12	42	80
• 1248.14.H63E	HSK-63E	14	44	80
• 1248.16.H63E	HSK-63E	16	48	80
• 1248.18.H63E	HSK-63E	18	50	80
• 1248.20.H63E	HSK-63E	20	52	80
• 1248.25.H63E	HSK-63E	25	64	110
• 1248.32.H63E	HSK-63E	32	64	110

• Disponibile solo su richiesta
Available only on demand
Verfügbar nur auf Anfrage
Disponibile seulement sur demande
Disponibles bajo petición

For Weldon end mill with cylindrical shank DIN 1835

Zum Spannen von zylindrischen Werkzeugschaften nach DIN 1835

Pour fraises avec attachement cylindrique DIN 1835

Para fresa de mango cilíndrico con weldon DIN 1835

RIDUZIONI A CONO MORSE PER PUNTE DIN 228-B

MORSE TAPER ADAPTER FOR TWIST DRILLS DIN 228-B
ZWISCHENHULSEN FÜR BOHRER DIN 228-B
REDUCTION CONE MORSE POUR FORETS DIN 228-B
ADAPTADOR CONO MORSE PARA BROCAS DIN 228-B

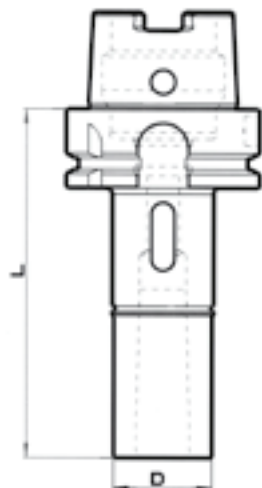

HSK - A+C

CODICE CODE BESTELL NR CODE CÓDIGO	ATTACCO SHANK AUFNAHMEN ATTACHEMENT MANGO	Cono Morse Morse cone Innenkegel Cone Morse Cono Morse	D	L
• 1308.01.H40A	HSK-40A	1	25	95
• 1308.02.H40A	HSK-40A	2	32	110
• 1308.03.H40A	HSK-40A	3	40	135
• 1308.01.H50A	HSK-50A	1	25	100
• 1308.02.H50A	HSK-50A	2	32	115
• 1308.03.H50A	HSK-50A	3	40	135
1308.01.H63A	HSK-63A	1	25	100
1308.02.H63A	HSK-63A	2	32	115
1308.03.H63A	HSK-63A	3	40	135
1308.04.H63A	HSK-63A	4	48	160
1308.02.H100A	HSK-100A	2	32	120
1308.03.H100A	HSK-100A	3	40	150
1308.04.H100A	HSK-100A	4	48	170

- Disponibile solo su richiesta
Available only on demand
Verfügbar nur auf Anfrage
Disponible seulement sur demande
Disponibles bajo petición

RIDUZIONE A CONO MORSE PER FRESE DIN 228-A

MORSE TAPER ADAPTER FOR MILLING CUTTERS DIN 228-A

ZWISCHENHULSEN FÜR FRÄSER DIN 228-A

REDUCTION CONE MORSE POUR FRAISES DIN 228-A

ADAPTADOR CONO MORSE PARA FRESAS DIN 228-A

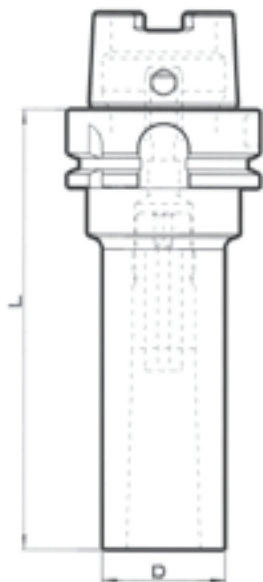

HSK - A+C

CODICE CODE BESTELL NR CODE CÓDIGO	ATTACCO SHANK AUFNAHMEN ATTACHEMENT MANGO	Cono Morse Morse cone Innenkegel Cone Morse Cono Morse	D	L
• 1338.01.H40A	HSK-40A	1	25	95
• 1338.02.H40A	HSK-40A	2	32	110
• 1338.03.H40A	HSK-40A	3	40	135
• 1338.01.H50A	HSK-50A	1	25	100
• 1338.02.H50A	HSK-50A	2	32	115
• 1338.03.H50A	HSK-50A	3	40	135
1338.01.H63A	HSK-63A	1	25	105
1338.02.H63A	HSK-63A	2	32	116
1338.03.H63A	HSK-63A	3	40	145
1338.04.H63A	HSK-63A	4	48	165
1338.02.H100A	HSK-100A	2	32	120
1338.03.H100A	HSK-100A	3	40	150
1338.04.H100A	HSK-100A	4	48	170

- Disponibile solo su richiesta
Available only on demand
Verfügbar nur auf Anfrage
Disponible seulement sur demande
Disponibles bajo petición

ATTACCO MODULARE

MODULAR SHANK
STEILKEGELADAPTER
ATTACHEMENT MODULAIRE
MANGO MODULAR

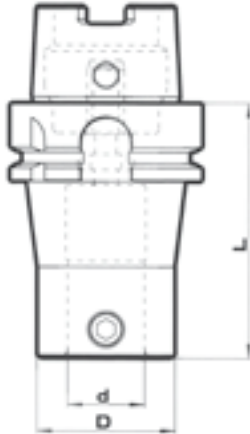

HSK - A+C

CODICE CODE BESTELL NR CODE CÓDIGO	ATTACCO SHANK AUFNAHMEN ATTACHEMENT MANGO	d	L	D
• 1808.25.H50A	HSK-50A	25	82	42
1808.25.H63A	HSK-63A	25	84	45
• 1808.25.H80A	HSK-80A	25	87	45
• 1808.40.H80A	HSK-80A	40	106	66
1808.25.H100A	HSK-100A	25	89	45
1808.40.H100A	HSK-100A	40	110	66

- Disponibile solo su richiesta
Available only on demand
Verfügbar nur auf Anfrage
Disponible seulement sur demande
Disponibles bajo petición



MANDRINI PORTA UTENSILI DIN 2080

DIN 2080 TOOL HOLDERS
WERKZEUGAUFNAHMEN DIN 2080

PORTE-OUTILS DIN 2080
PORTAHERRAMIENTAS DIN 2080

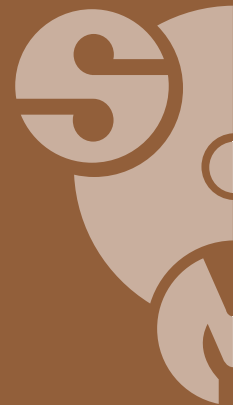

PORTAFRESA A TRASCINAMENTO FISSO

UNIVERSAL MILLING CUTTER HOLDER
AUFSTECKFRAESERDORNE
PORTE FRAISE ENTRAINEMENT FIXE
PORTA FRESAS UNIVERSAL

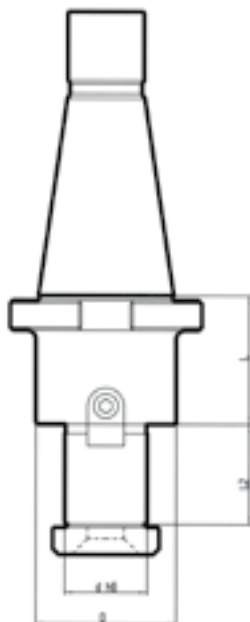

DIN 2080

CODICE CODE BESTELL NR CODE CÓDIGO	ATTACCO SHANK AUFNAHMEN ATTACHEMENT MANGO	d	D	L2	L
1086.16.40	40	16	38	17	45
1086.22.40	40	22	48	19	45
1086.27.40	40	27	58	21	45
1086.32.40	40	32	78	24	50
1086.40.40	40	40	88	27	55
1086.16.50	50	16	38	17	45
1086.22.50	50	22	48	19	45
1086.27.50	50	27	58	21	45
1086.32.50	50	32	78	24	50
1086.40.50	50	40	88	27	50

PORTAFRESA A TRASCINAMENTO COMBINATO

COMBI-SHELL MILL ADAPTOR
 KOMBI-AUFSTECKFRAESERDORNE
 PORTE FRAISE A DOUBLE USAGE
 ADAPTADOR PORTA FRESAS COMBINADO

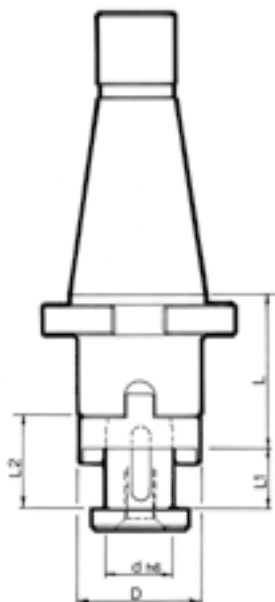

DIN 2080

CODICE CODE BESTELL NR CODE CÓDIGO	ATTACCO SHANK AUFNAHMEN ATTACHEMENT MANGO	d	L1	L2	L	D
1106.16.40	40	16	17	27	52	32
1106.22.40	40	22	19	31	52	40
1106.27.40	40	27	21	33	52	48
1106.32.40	40	32	24	38	52	58
1106.40.40	40	40	27	41	52	70
1106.16.50	50	16	17	27	55	32
1106.22.50	50	22	19	31	55	40
1106.27.50	50	27	21	33	55	48
1106.32.50	50	32	24	38	55	58
1106.40.50	50	40	27	41	55	70

PORTAPINZA A GRANDE CAPACITA' DI SERRAGGIO PER PINZE DIN 6499

COLLET CHUCK FOR DIN 6499 COLLETS

SPANNZANGENFUTTER DIN 6499

PORTE PINCES POUR PINCES DIN 6499

PORTA PINZAS DIN 6499

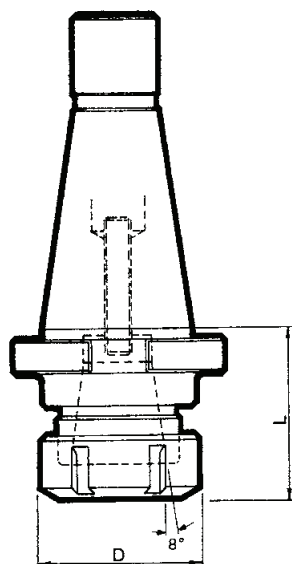

DIN 2080

CODICE CODE BESTELL NR CODE CÓDIGO	ATTACCO SHANK AUFNAHMEN ATTACHEMENT MANGO	D	L	Pinze ER ER Collets Zangen ER Pinces ER Pinzas ER
1196.25.40N	40	42	53	25
1196.32.40N	40	50	68	32
1196.40.40N	40	63	80	40
1196.32.50N	50	50	68	32
1196.40.50N	50	63	76	40
Prolungati Extended Verlängerte Prolongé Extendido				
* 3196.16.40N	40	28	150	16
2196.32.40N	40	50	110	32
* 2196.16.50N	50	28	100	16
* 3196.16.50N	50	28	150	16
2196.32.50N	50	50	140	32
2196.40.50N	50	63	140	40

* **Fino ad esaurimento scorte**
Subject to the selling out
Bis zumrestlosen Ausverkauf der Ware
Jusqu'à épuisement du stock
Hasta el final de existencias almacén

Per utensili con gambo cilindrico.

For cylindrical shank tools.

Zur Aufnahme von Werkzeugen mit Zylinderschaft in Spannzangen.

Pour outils avec queue cylindrique

Para herramientas de mango cilíndrico

PORTAPINZA CON GHIERA GIREVOLE A GRANDE CAPACITA' DI SERRAGGIO PER PINZE DIN6499

COLLET CHUCK WITH BALL BEARING FOR DIN 6499 COLLETS
 SPANNZANGENFUTTER MIT DREHENDER NUTMUTTER DIN 6499
 PORTE PINCES AVEC BAGUE TOURNANTE POUR PINCES DIN 6499
 PORTA PINZAS CON COJINETE PARA PINZAS DIN 6499

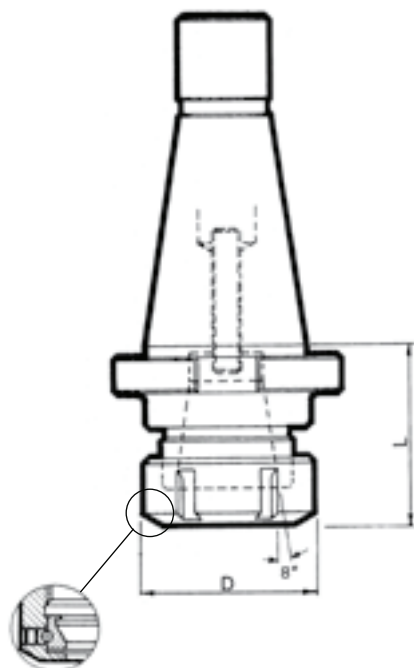
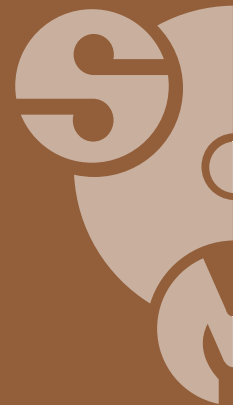

DIN 2080

CODICE CODE BESTELL NR CODE CÓDIGO	ATTACCO SHANK AUFNAHMEN ATTACHEMENT MANGO	D	L	Pinze ER ER Collet Zangen ER Pinces ER Pinzas ER
1196.25.40G	40	42	53	25
1196.32.40G	40	50	68	32
1196.32.50G	50	50	68	32
1196.40.50G	50	63	76	40

Per evitare la rotazione della pinza durante la chiusura.

To avoid any rotation of the collet during the closure.

Um die Rotation der Zange während der Schließung zu vermeiden.

Pour éviter la rotation de la pince pendant le serrage.

Para evitar la rotación de la pinza durante el cierre.

Per utensili con gambo cilindrico.

Ring nut for cylindrical shank tools.

Zur Aufnahme von Werkzeugen mit Zylinderschaft in Spannzangen.

Pour outils avec queue cylindrique.

Tuerca de anillo para herramientas de mango cilíndrico

ATTACCO PER FRESE TIPO WELDON DIN 1835

WELDON SHANK
WELDON AUFNAHMEN
MANDRIN POUR OUTILS TYPE WELDON
MANGO WELDON

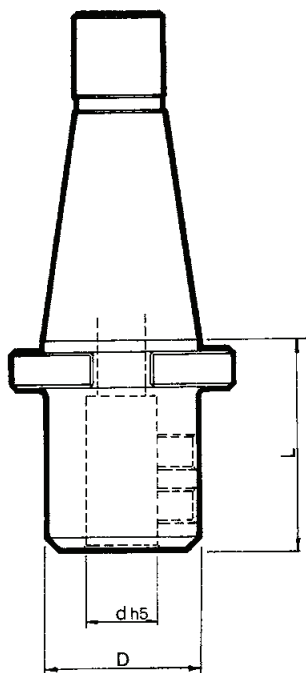

DIN 2080

CODICE CODE BESTELL NR CODE CÓDIGO	ATTACCO SHANK AUFNAHMEN ATTACHEMENT MANGO	d	D	L
1246.06.40	40	6	25	50
1246.08.40	40	8	28	50
1246.10.40	40	10	35	50
1246.12.40	40	12	42	50
1246.16.40	40	16	48	63
1246.20.40	40	20	52	63
1246.25.40	40	25	65	90
1246.32.40	40	32	72	90
1246.06.50	50	6	25	50
1246.08.50	50	8	28	50
1246.10.50	50	10	35	63
1246.12.50	50	12	42	63
1246.16.50	50	16	48	63
1246.20.50	50	20	52	63
1246.25.50	50	25	65	80
1246.32.50	50	32	72	85
1246.40.50	50	40	78	95

For Weldon end mill with cylindrical shank DIN 1835

Zum Spannen von zylindrischen Werkzeugschaften nach DIN 1835

Pour fraises avec attachement cylindrique DIN 1835

Para fresa de mango cilíndrico con weldon DIN 1835

RIDUZIONI A CONO MORSE PER PUNTE DIN 228-B

MORSE TAPER ADAPTER FOR TWIST DRILLS DIN 228-B
ZWISCHENHULSEN FÜR BOHRER DIN 228-B
REDUCTION CONE MORSE POUR FORETS DIN 228-B
ADAPTADOR CONO MORSE PARA BROCAS DIN 228-B

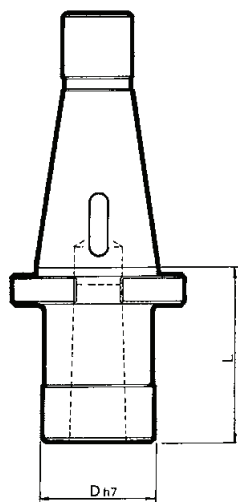

DIN 2080

CODICE CODE BESTELL NR CODE CÓDIGO	ATTACCO SHANK AUFNAHMEN ATTACHEMENT MANGO	Cono Morse Morse cone Innenkegel Cone Morse Cono Morse	D	L
1306.01.40	40	1	25	50
1306.02.40	40	2	32	50
1306.03.40	40	3	40	65
1306.04.40	40	4	48	95
1306.01.50	50	1	25	45
1306.02.50	50	2	32	60
1306.03.50	50	3	40	65
1306.04.50	50	4	48	70
1306.05.50	50	5	63	105

For Weldon end mill with cylindrical shank DIN 1835

Zum Spannen von zylindrischen Werkzeugschaften nach DIN 1835

Pour fraises avec attachement cylindrique DIN 1835

Para fresa de mango cilíndrico con weldon DIN 1835

RIDUZIONE A CONO MORSE PER FRESE DIN 228-A

MORSE TAPER ADAPTER FOR MILLING CUTTERS DIN 228-A

ZWISCHENHULSEN FÜR FRÄSER DIN 228-A

REDUCTION CONE MORSE POUR FRAISES DIN 228-A

ADAPTADOR CONO MORSE PARA FRESAS DIN 228-A

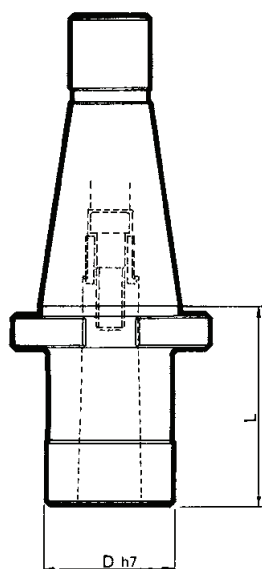

DIN 2080

CODICE CODE BESTELL NR CODE CÓDIGO	ATTACCO SHANK AUFNAHMEN ATTACHEMENT MANGO	Cono Morse Morse cone Innenkegel Cone Morse Cono Morse	D	L
1336.01.40	40	1	25	50
1336.02.40	40	2	32	50
1336.03.40	40	3	40	65
1336.04.40	40	4	48	95
1336.01.50	50	1	25	45
1336.02.50	50	2	32	60
1336.03.50	50	3	40	65
1336.04.50	50	4	48	65
1336.05.50	50	5	63	120

ATTACCO PER ASTUCCI REGISTRABILI DIN 6327

ADJUSTABLE SHANK HOLDER DIN 6327
PENDELHALTER DIN 6327
MANDRIN POUR DOUILLES DE REGLAGE DIN 6327
PORTA MANGO AJUSTABLE DIN 6327

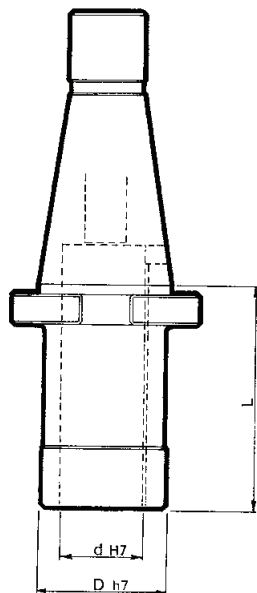

DIN 2080

CODICE CODE BESTELL NR CODE CÓDIGO	ATTACCO SHANK AUFNAHMEN ATTACHEMENT MANGO	d	D	L
* 1536.20.40	40	20	44	52
1536.28.40	40	28	50	100
1536.36.40	40	36	63	120
1536.28.50	50	28	50	100
1536.36.50	50	36	63	100
* 1536.48.50	50	50	70	114

* **Fino ad esaurimento scorte**
Subject to the selling out
Bis zum restlosen Ausverkauf der Ware
Jusqu'à épuisement du stock
Hasta el final de existencias almacén

ATTACCO PER MANDRINI PORTAPUNTE DIN 238

CHUCK DRILL HOLDER DIN 238

BOHRFUTTERAUFNAHMEN DIN 238

ATTACHEMENT POUR MANDRINS DE PERCAGE DIN 238

CONO PORTA BROCAS DIN 238

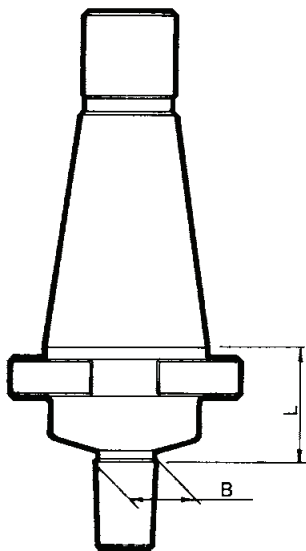

DIN 2080

CODICE CODE BESTELL NR CODE CÓDIGO	ATTACCO SHANK AUFNAHMEN ATTACHEMENT MANGO	DIN 238	B	L
* 1576.12.40	40	B12	12,07	25
1576.16.40	40	B16	15,73	17
1576.18.40	40	B18	17,78	17
1576.16.50	50	B16	15,73	20
1576.18.50	50	B18	17,78	20

*** Fino ad esaurimento scorte**

Subject to the selling out

Bis zum restlosen Ausverkauf der Ware

Jusqu'à épuisement du stock

Hasta el final de existencias almacén

BARRE A STELO TENERO

BLANK TOOL-HOLDER
ROHLINGE ZUR BEARBEITUNG VON SONDERAUSFÜHRUNGEN
BARRES D'ALESAGE SEMI-FINIES
BARRAS CON MANGO BLANDO

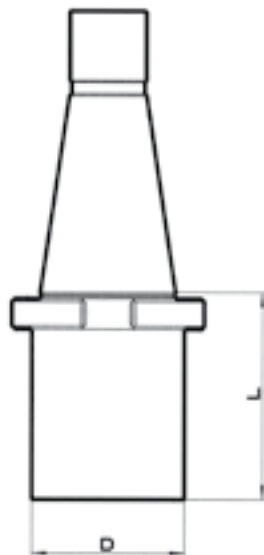

DIN 2080

CODICE CODE BESTELL NR CODE CÓDIGO	ATTACCO SHANK AUFNAHMEN ATTACHEMENT MANGO	D	L
1606.40.40	40	40	160
1606.63.40	40	63	160
1606.80.50	50	80	200



MANDRINI PORTA UTENSILI DIN 69871-A



DIN 69871-A TOOL HOLDERS
WERKZEUGAUFNAHMEN DIN 69871-A

PORTE-OUTILS DIN 69871-A
PORTAHERRAMIENTAS DIN 69871-A



PORTAFRESA A TRASCINAMENTO FISSO

UNIVERSAL MILLING CUTTER HOLDER
AUFSTECKFRAESERDORNE
PORTE FRAISE ENTRAINEMENT FIXE
PORTA FRESAS UNIVERSAL

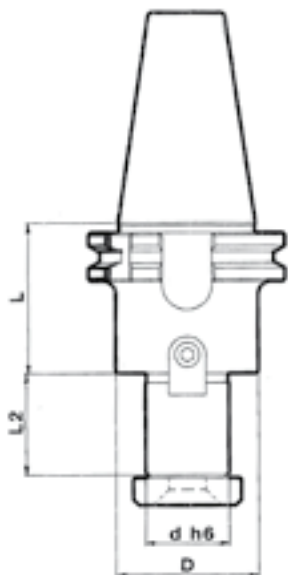

DIN 69871-A

CODICE CODE BESTELL NR CODE CÓDIGO	ATTACCO SHANK AUFNAHMEN ATTACHEMENT MANGO	d	D	L2	L
1086.16.30A	30	16	38	17	35
1086.22.30A	30	22	48	19	35
1086.27.30A	30	27	58	21	50
1086.16.40A	40	16	38	17	45
1086.22.40A	40	22	48	19	45
1086.27.40A	40	27	58	21	50
1086.32.40A	40	32	78	24	55
1086.40.40A	40	40	88	27	55
1086.16.50A	50	16	38	17	45
1086.22.50A	50	22	48	19	45
1086.27.50A	50	27	58	21	45
1086.32.50A	50	32	78	24	50
1086.40.50A	50	40	88	27	55

PORTAFRESA A TRASCINAMENTO COMBINATO

COMBI-SHELL MILL ADAPTOR
 KOMBI-AUFSTECKFRAESERDORNE
 PORTE FRAISE A DOUBLE USAGE
 ADAPTADOR PORTA FRESAS COMBINADO

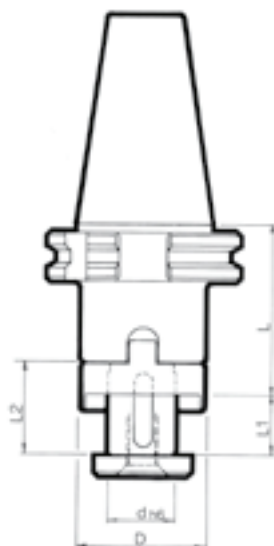

DIN 69871-A

CODICE CODE BESTELL NR CODE CÓDIGO	ATTACCO SHANK AUFNAHMEN ATTACHEMENT MANGO	d	L1	L2	L	D
1106.16.30A	30	16	17	27	50	32
1106.22.30A	30	22	19	31	50	40
1106.27.30A	30	27	21	33	55	48
1106.16.40A	40	16	17	27	55	32
1106.22.40A	40	22	19	31	55	40
1106.27.40A	40	27	21	33	55	48
1106.32.40A	40	32	24	38	60	58
1106.40.40A	40	40	27	41	60	70
1106.16.50A	50	16	17	27	55	32
1106.22.50A	50	22	19	31	55	40
1106.27.50A	50	27	21	33	55	48
1106.32.50A	50	32	24	38	55	58
1106.40.50A	50	40	27	41	55	70

PORTAPINZA A GRANDE CAPACITA' DI SERRAGGIO PER PINZE DIN 6499

COLLET CHUCK FOR DIN 6499 COLLETS

SPANNZANGENFUTTER DIN 6499

PORTE PINCES POUR PINCES DIN 6499

PORTA PINZAS DIN 6499

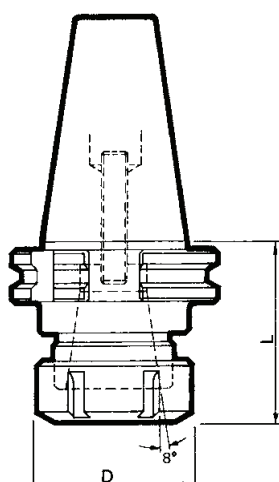

DIN 69871-A

CODICE CODE BESTELL NR CODE CÓDIGO	ATTACCO SHANK AUFNAHMEN ATTACHEMENT MANGO	D	L	Pinze ER ER Collets Zangen ER Pincas ER Pinzas ER
1196.16.30AN	30	32	55	16
1196.25.30AN	30	42	55	25
1196.32.30AN	30	50	60	32
1196.25.40AN	40	42	70	25
1196.32.40AN	40	50	70	32
1196.32.50AN	50	50	70	32
1196.40.50AN	50	63	80	40
Prolungati Extended Verlängerte Prolongé Extendido				
2196.16.40AN	40	32	100	16
3196.16.40AN	40	32	150	16
2196.32.40AN	40	50	100	32
2196.16.50AN	50	32	100	16
3196.16.50AN	50	28	150	16
2196.32.50AN	50	50	100	32

Per utensili con gambo cilindrico.

For cylindrical shank tools.

Zur Aufnahme von Werkzeugen mit Zylinderschaft in Spannzangen.

Pour outils avec queue cylindrique

Para herramientas de mango cilíndrico

PORTAPINZA CON GHIERA GIREVOLE A GRANDE CAPACITA' DI SERRAGGIO PER PINZE DIN6499

COLLET CHUCK WITH BALL BEARING FOR DIN 6499 COLLETS
 SPANZANGENFUTTER MIT DREHENDER NUTMUTTER DIN 6499
 PORTE PINCES AVEC BAGUE TOURNANTE POUR PINCES DIN 6499
 PORTA PINZAS CON COJINETE PARA PINZAS DIN 6499

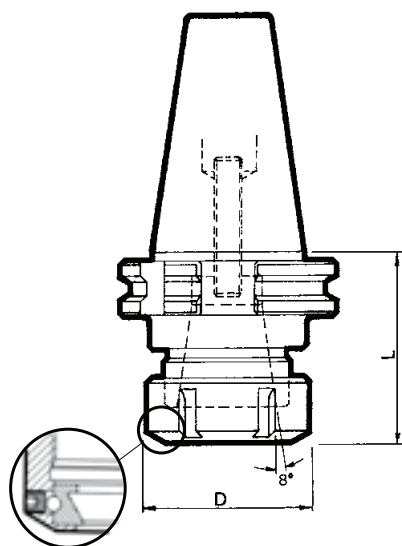

DIN 69871-A

CODICE CODE BESTELL NR CODE CÓDIGO	ATTACCO SHANK AUFNAHMEN ATTACHEMENT MANGO	D	L	Pinze ER ER Collet Zangen ER Pinces ER Pinzas ER
1196.25.40AG	40	42	70	25
1196.32.40AG	40	50	70	32
1196.32.50AG	50	50	80	32
1196.40.50AG	50	63	80	40

Per evitare la rotazione della pinza durante la chiusura.

To avoid any rotation of the collet during the closure.

Um die Rotation der Zange während der Schließung zu vermeiden.

Pour éviter la rotation de la pince pendant le serrage.

Para evitar la rotación de la pinza durante el cierre.

Per utensili con gambo cilindrico.

Ring nut for cylindrical shank tools.

Zur Aufnahme von Werkzeugen mit Zylinderschaft in Spannzangen.

Pour outils avec queue cylindrique.

Tuerca de anillo para herramientas de mango cilíndrico

ATTACCO PER FRESE TIPO WELDON DIN 1835

WELDON SHANK
WELDON AUFNAHMEN
MANDRIN POUR OUTILS TYPE WELDON
MANGO WELDON

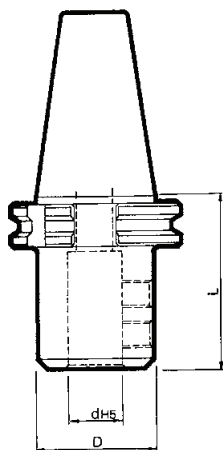

DIN 69871-A

CODICE CODE BESTELL NR CODE CÓDIGO	ATTACCO SHANK AUFNAHMEN ATTACHEMENT MANGO	d	D	L
1246.06.30A	30	6	25	45
1246.08.30A	30	8	28	45
1246.10.30A	30	10	35	50
1246.12.30A	30	12	42	50
1246.16.30A	30	16	48	70
1246.20.30A	30	20	52	70
1246.06.40A	40	6	25	50
1246.08.40A	40	8	28	50
1246.10.40A	40	10	35	50
1246.12.40A	40	12	42	50
1246.16.40A	40	16	48	63
1246.20.40A	40	20	52	63
1246.25.40A	40	25	65	100
1246.32.40A	40	32	72	100
1246.06.50A	50	6	25	63
1246.08.50A	50	8	28	63
1246.10.50A	50	10	35	63
1246.12.50A	50	12	42	63
1246.16.50A	50	16	48	63
1246.20.50A	50	20	52	63
1246.25.50A	50	25	65	80
1246.32.50A	50	32	72	100
1246.40.50A	50	40	80	120
1246.50.50A	50	50	100	120

For Weldon end mill with cylindrical shank DIN 1835

Zum Spannen von zylindrischen Werkzeugschaften nach DIN 1835

Pour fraises avec attachement cylindrique DIN 1835

Para fresa de mango cilíndrico con weldon DIN 1835

RIDUZIONI A CONO MORSE PER PUNTE DIN 228-B

MORSE TAPER ADAPTER FOR TWIST DRILLS DIN 228-B
ZWISCHENHULSEN FÜR BOHRER DIN 228-B
REDUCTION CONE MORSE POUR FORETS DIN 228-B
ADAPTADOR CONO MORSE PARA BROCAS DIN 228-B

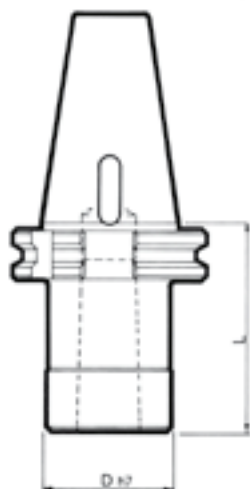

DIN 69871-A

CODICE CODE BESTELL NR CODE CÓDIGO	ATTACCO SHANK AUFNAHMEN ATTACHEMENT MANGO	Cono Morse Morse cone Innenkegel Cone Morse Cono Morse	D	L
1306.01.30A	30	1	25	55
1306.02.30A	30	2	32	60
1306.03.30A	30	3	40	90
1306.01.40A	40	1	25	50
1306.02.40A	40	2	32	50
1306.03.40A	40	3	40	70
1306.04.40A	40	4	48	95
1306.01.50A	50	1	25	50
1306.02.50A	50	2	32	60
1306.03.50A	50	3	40	65
1306.04.50A	50	4	48	95
1306.05.50A	50	5	63	120

RIDUZIONE A CONO MORSE PER FRESE DIN 228-A

MORSE TAPER ADAPTER FOR MILLING CUTTERS DIN 228-A

ZWISCHENHULSEN FÜR FRÄSER DIN 228-A

REDUCTION CONE MORSE POUR FRAISES DIN 228-A

ADAPTADOR CONO MORSE PARA FRESAS DIN 228-A

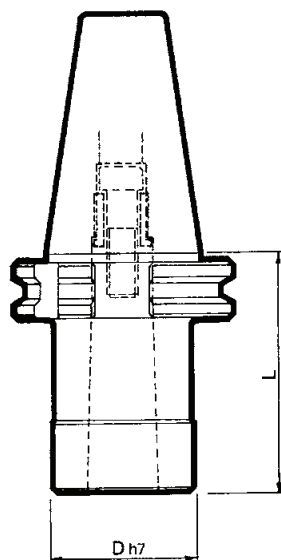

DIN 69871-A

CODICE CODE BESTELL NR CODE CÓDIGO	ATTACCO SHANK AUFNAHMEN ATTACHEMENT MANGO	Cono Morse Morse cone Innenkegel Cone Morse Cono Morse	D	L
1336.01.30A	30	1	25	50
1336.02.30A	30	2	32	60
1336.03.30A	30	3	40	80
1336.01.40A	40	1	25	50
1336.02.40A	40	2	32	50
1336.03.40A	40	3	40	70
1336.04.40A	40	4	48	95
1336.01.50A	50	1	25	45
1336.02.50A	50	2	32	60
1336.03.50A	50	3	40	65
1336.04.50A	50	4	48	95
1336.05.50A	50	5	63	120

ATTACCO PER ASTUCCI REGISTRABILI DIN 6327

ADJUSTABLE SHANK HOLDER DIN 6327
PENDELHALTER DIN 6327
MANDRIN POUR DOUILLES DE REGLAGE DIN 6327
PORTA MANGO AJUSTABLE DIN 6327

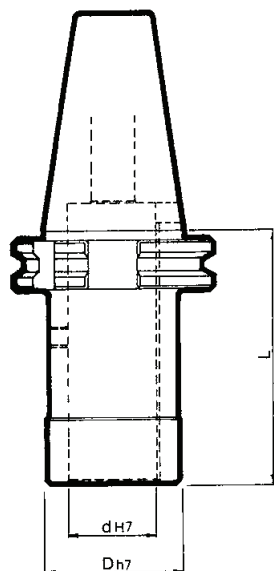

DIN 69871-A

CODICE CODE BESTELL NR CODE CÓDIGO	ATTACCO SHANK AUFNAHMEN ATTACHEMENT MANGO	d	D	L
* 1536.20.40A	40	20	44	70
1536.28.40A	40	28	50	70
1536.36.40A	40	36	63	120
1536.28.50A	50	28	50	100
1536.36.50A	50	36	63	100
* 1536.48.50A	50	48	70	120

* **Fino ad esaurimento scorte**
Subject to the selling out
Bis zum restlosen Ausverkauf der Ware
Jusqu'à épuisement du stock
Hasta el final de existencias almacén

ATTACCO PER MANDRINI PORTAPUNTE DIN 238

CHUCK DRILL HOLDER DIN 238

BOHRFUTTERAUFNAHMEN DIN 238

ATTACHEMENT POUR MANDRINS DE PERCAGE DIN 238

CONO PORTA BROCCAS DIN 238

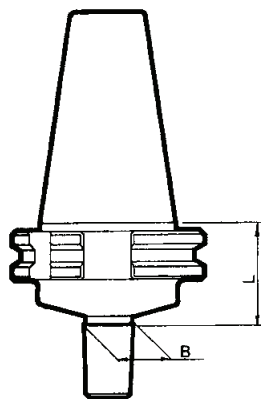

DIN 69871-A

CODICE CODE BESTELL NR CODE CÓDIGO	ATTACCO SHANK AUFNAHMEN ATTACHEMENT MANGO	DIN 238	B	L
1576.12.30A	30	B12	12,07	40
1576.16.30A	30	B16	15,73	40
*1576.12.40A	40	B12	12,07	40
1576.16.40A	40	B16	15,73	40
1576.18.40A	40	B18	17,78	40
1576.16.50A	50	B16	15,73	50
1576.18.50A	50	B18	17,78	50

* **Fino ad esaurimento scorte**

Subject to the selling out

Bis zum restlosen Ausverkauf der Ware

Jusqu'à épuisement du stock

Hasta el final de existencias almacén

BARRE A STELO TENERO

BLANK TOOL-HOLDER
ROHLINGE ZUR BEARBEITUNG VON SONDERAUSFÜHRUNGEN
BARRES D'ALESAGE SEMI-FINIES
BARRAS CON MANGO BLANDO

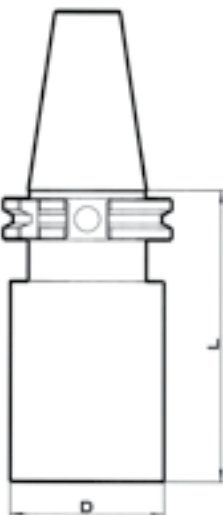

DIN 69871-A

CODICE CODE BESTELL NR CODE CÓDIGO	ATTACCO SHANK AUFNAHMEN ATTACHEMENT MANGO	D	L
1606.40.40A	40	40,5	160
1606.63.40A	40	63,5	160
1606.80.50A	50	80	200



MANDRINI PORTA UTENSILI MAS 403 BT

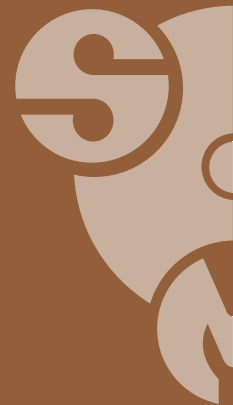

MAS 403 BT TOOL HOLDERS
WERKZEUGAUFNAHMEN MAS 403 BT

PORTE-OUTILS MAS 403 BT
PORTAHERRAMIENTAS MAS 403 BT



PORTAFRESA A TRASCINAMENTO FISSO

UNIVERSAL MILLING CUTTER HOLDER
AUFSTECKFRAESERDORNE
PORTE FRAISE ENTRAINEMENT FIXE
PORTA FRESAS UNIVERSAL

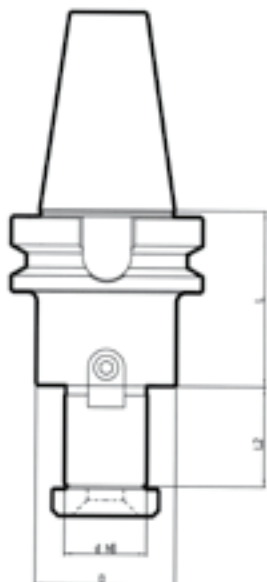

MAS 403 BT

CODICE CODE BESTELL NR CODE CÓDIGO	ATTACCO SHANK AUFNAHMEN ATTACHEMENT MANGO	d	D	L2	L
1086.16.30BT	30	16	38	17	35
1086.22.30BT	30	22	48	19	40
1086.27.30BT	30	27	58	21	40
1086.16.40BT	40	16	38	17	45
1086.22.40BT	40	22	48	19	45
1086.27.40BT	40	27	58	21	45
1086.32.40BT	40	32	78	24	50
1086.40.40BT	40	40	88	27	55
1086.16.50BT	50	16	38	17	60
1086.22.50BT	50	22	48	19	60
1086.27.50BT	50	27	58	21	60
1086.32.50BT	50	32	78	24	60
1086.40.50BT	50	40	88	27	60

PORTAFRESA A TRASCINAMENTO COMBINATO

COMBI-SHELL MILL ADAPTOR
KOMBI-AUFSTECKFRAESERDORNE
PORTE FRAISE A DOUBLE USAGE
ADAPTADOR PORTA FRESAS COMBINADO

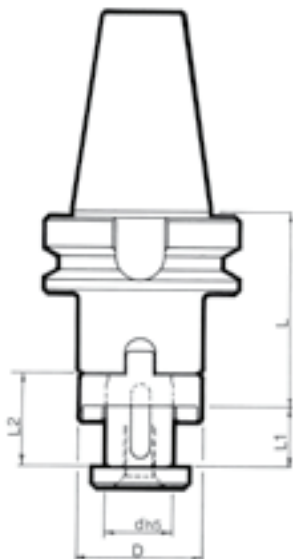

MAS 403 BT

CODICE CODE BESTELL NR CODE CÓDIGO	ATTACCO SHANK AUFNAHMEN ATTACHEMENT MANGO	d	L1	L2	L	D
1106.16.30BT	30	16	17	27	50	32
1106.22.30BT	30	22	19	31	50	40
1106.27.30BT	30	27	21	33	55	48
1106.16.40BT	40	16	17	27	55	32
1106.22.40BT	40	22	19	31	55	40
1106.27.40BT	40	27	21	33	55	48
1106.32.40BT	40	32	24	38	60	58
1106.40.40BT	40	40	27	41	60	70
1106.16.50BT	50	16	17	27	70	32
1106.22.50BT	50	22	19	31	70	40
1106.27.50BT	50	27	21	33	70	48
1106.32.50BT	50	32	24	38	70	58
1106.40.50BT	50	40	27	41	70	70

PORTAPINZA A GRANDE CAPACITA' DI SERRAGGIO PER PINZE DIN 6499

COLLET CHUCK FOR DIN 6499 COLLETS

SPANNZANGENFUTTER DIN 6499

PORTE PINCES POUR PINCES DIN 6499

PORTA PINZAS DIN 6499

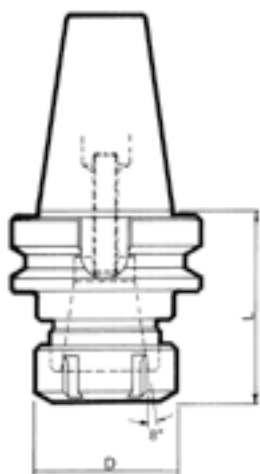

MAS 403 BT

CODICE CODE BESTELL NR CODE CÓDIGO	ATTACCO SHANK AUFNAHMEN ATTACHEMENT MANGO	D	L	Pinze ER ER Collets Zangen ER Pinces ER Pinzas ER
1196.16.30BTN	30	32	55	16
1196.25.30BTN	30	42	55	25
1196.32.30BTN	30	50	60	32
1196.25.40BTN	40	42	70	25
1196.32.40BTN	40	50	70	32
1196.32.50BTN	50	50	80	32
1196.40.50BTN	50	63	80	40
Prolungati Extended Verlängerte Prolongé Extendido				
2196.16.40BTN	40	32	100	16
3196.16.40BTN	40	28	150	16
2196.32.40BTN	40	50	100	32
2196.16.50BTN	50	32	100	16
3196.16.50BTN	50	28	150	16
2196.32.50BTN	50	50	100	32

Per utensili con gambo cilindrico.

For cylindrical shank tools.

Zur Aufnahme von Werkzeugen mit Zylinderschaft in Spannzangen.

Pour outils avec queue cylindrique

Para herramientas de mango cilíndrico

PORTAPINZA CON GHIERA GIREVOLE A GRANDE CAPACITA' DI SERRAGGIO PER PINZE DIN6499

COLLET CHUCK WITH BALL BEARING FOR DIN 6499 COLLETS
SPANNZANGENFUTTER MIT DREHENDER NUTMUTTER DIN 6499
PORTE PINCES AVEC BAGUE TOURNANTE POUR PINCES DIN 6499
PORTA PINZAS CON COJINETE PARA PINZAS DIN 6499

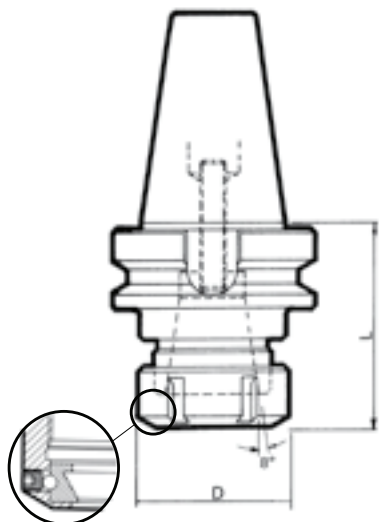

MAS 403 BT

CODICE CODE BESTELL NR CODE CÓDIGO	ATTACCO SHANK AUFNAHMEN ATTACHEMENT MANGO	D	L	Pinze ER ER Collet Zangen ER Pinces ER Pinzas ER
1196.25.40BTG	40	42	70	25
1196.32.40BTG	40	50	70	32
1196.32.50BTG	50	50	80	32
1196.40.50BTG	50	63	80	40

Per evitare la rotazione della pinza durante la chiusura.

To avoid any rotation of the collet during the closure.

Um die Rotation der Zange während der Schließung zu vermeiden.

Pour éviter la rotation de la pince pendant le serrage.

Para evitar la rotación de la pinza durante el cierre.

Per utensili con gambo cilindrico.

Ring nut for cylindrical shank tools.

Zur Aufnahme von Werkzeugen mit Zylinderschaft in Spannzangen.

Pour outils avec queue cylindrique.

Tuerca de anillo para herramientas de mango cilíndrico

ATTACCO PER FRESE TIPO WELDON DIN 1835

WELDON SHANK
WELDON AUFNAHMEN
MANDRIN POUR OUTILS TYPE WELDON
MANGO WELDON

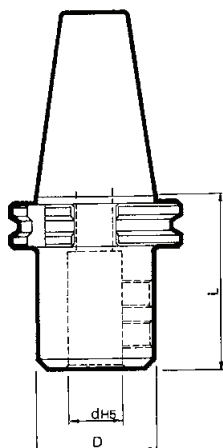

MAS 403 BT

CODICE CODE BESTELL NR CODE CÓDIGO	ATTACCO SHANK AUFNAHMEN ATTACHEMENT MANGO	d	D	L
1246.06.30BT	30	6	25	50
1246.08.30BT	30	8	28	50
1246.10.30BT	30	10	35	50
1246.12.30BT	30	12	42	55
1246.16.30BT	30	16	48	63
1246.20.30BT	30	20	52	70
1246.06.40BT	40	6	25	50
1246.08.40BT	40	8	28	50
1246.10.40BT	40	10	35	63
1246.12.40BT	40	12	42	63
1246.16.40BT	40	16	48	63
1246.20.40BT	40	20	52	63
1246.25.40BT	40	25	65	90
1246.32.40BT	40	32	72	100
1246.06.50BT	50	6	25	63
1246.08.50BT	50	8	28	63
1246.10.50BT	50	10	35	70
1246.12.50BT	50	12	42	80
1246.16.50BT	50	16	48	80
1246.20.50BT	50	20	52	80
1246.25.50BT	50	25	65	100
1246.32.50BT	50	32	72	105
1246.40.50BT	50	40	80	120
1246.50.50BT	50	50	100	125

For Weldon end mill with cylindrical shank DIN 1835

Zum Spannen von zylindrischen Werkzeugschaften nach DIN 1835

Pour fraises avec attachement cylindrique DIN 1835

Para fresa de mango cilíndrico con weldon DIN 1835

RIDUZIONI A CONO MORSE PER PUNTE DIN 228-B

MORSE TAPER ADAPTER FOR TWIST DRILLS DIN 228-B
ZWISCHENHULSEN FÜR BOHRER DIN 228-B
REDUCTION CONE MORSE POUR FORETS DIN 228-B
ADAPTADOR CONO MORSE PARA BROCCAS DIN 228-B

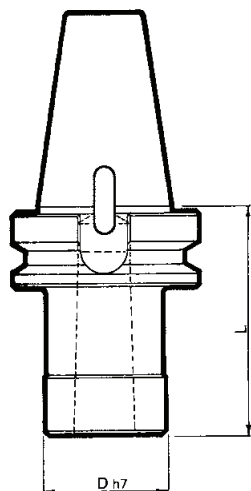

MAS 403 BT

CODICE CODE BESTELL NR CODE CÓDIGO	ATTACCO SHANK AUFNAHMEN ATTACHEMENT MANGO	Cono Morse Morse cone Innenkegel Cone Morse Cono Morse	D	L
1306.01.30BT	30	1	25	50
1306.02.30BT	30	2	32	60
1306.03.30BT	30	3	40	79
1306.01.40BT	40	1	25	50
1306.02.40BT	40	2	32	50
1306.03.40BT	40	3	40	70
1306.04.40BT	40	4	48	95
1306.01.50BT	50	1	25	45
1306.02.50BT	50	2	32	60
1306.03.50BT	50	3	40	65
1306.04.50BT	50	4	48	70
1306.05.50BT	50	5	63	105

RIDUZIONE A CONO MORSE PER FRESE DIN 228-A

MORSE TAPER ADAPTER FOR MILLING CUTTERS DIN 228-A

ZWISCHENHULSEN FÜR FRÄSER DIN 228-A

REDUCTION CONE MORSE POUR FRAISES DIN 228-A

ADAPTADOR CONO MORSE PARA FRESAS DIN 228-A

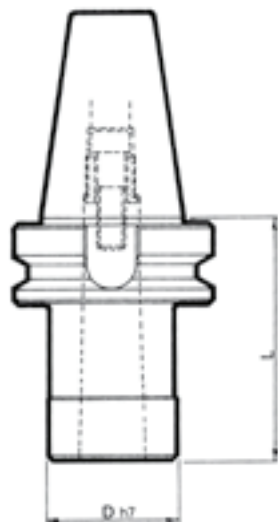

MAS 403 BT

CODICE CODE BESTELL NR CODE CÓDIGO	ATTACCO SHANK AUFNAHMEN ATTACHEMENT MANGO	Cono Morse Morse cone Innenkegel Cone Morse Cono Morse	D	L
1336.01.30BT	30	1	25	50
1336.02.30BT	30	2	32	60
1336.03.30BT	30	3	40	80
1336.01.40BT	40	1	25	50
1336.02.40BT	40	2	32	50
1336.03.40BT	40	3	40	70
1336.04.40BT	40	4	48	95
1336.01.50BT	50	1	25	45
1336.02.50BT	50	2	32	60
1336.03.50BT	50	3	40	65
1336.04.50BT	50	4	48	90
1336.05.50BT	50	5	63	118

ATTACCO PER ASTUCCI REGISTRABILI DIN 6327

ADJUSTABLE SHANK HOLDER DIN 6327
PENDELHALTER DIN 6327
MANDRIN POUR DOUILLES DE REGLAGE DIN 6327
PORTA MANGO AJUSTABLE DIN 6327

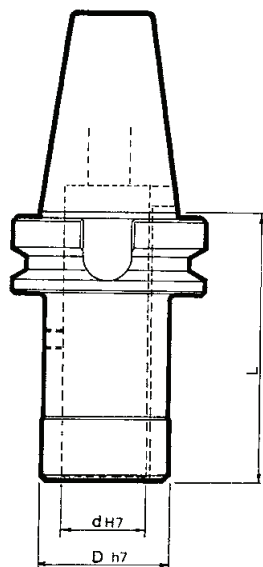

MAS 403 BT

CODICE CODE BESTELL NR CODE CÓDIGO	ATTACCO SHANK AUFNAHMEN ATTACHEMENT MANGO	d	D	L
* 1536.20.40BT	40	20	44	70
1536.28.40BT	40	28	50	70
1536.36.40BT	40	36	63	120
1536.28.50BT	50	28	50	100
1536.36.50BT	50	36	63	100

* **Fino ad esaurimento scorte**
Subject to the selling out
Bis zum restlosen Ausverkauf der Ware
Jusqu'à épuisement du stock
Hasta el final de existencias almacèn

ATTACCO PER MANDRINI PORTAPUNTE DIN 238

CHUCK DRILL HOLDER DIN 238

BOHRFUTTERAUFNAHMEN DIN 238

ATTACHEMENT POUR MANDRINS DE PERCAGE DIN 238

CONO PORTA BROCCAS DIN 238

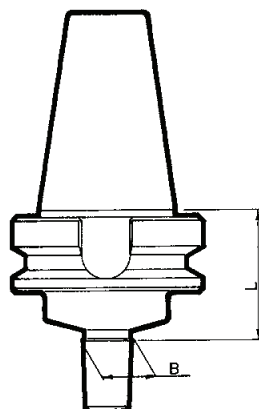

MAS 403 BT

CODICE CODE BESTELL NR CODE CÓDIGO	ATTACCO SHANK AUFNAHMEN ATTACHEMENT MANGO	DIN 238	B	L
1576.12.30BT	30	B12	12	40
1576.16.30BT	30	B16	16	40
* 1576.12.40BT	40	B12	12	40
1576.16.40BT	40	B16	16	40
1576.18.40BT	40	B18	18	40
1576.16.50BT	50	B16	16	50
1576.18.50BT	50	B18	18	50

* **Fino ad esaurimento scorte**

Subject to the selling out

Bis zum restlosen Ausverkauf der Ware

Jusqu'à épuisement du stock

Hasta el final de existencias almacén

BARRE A STELO TENERO

BLANK TOOL-HOLDER
ROHLINGE ZUR BEARBEITUNG VON SONDERAUSFÜHRUNGEN
BARRES D'ALEPAGE SEMI-FINIES
BARRAS CON MANGO BLANDO

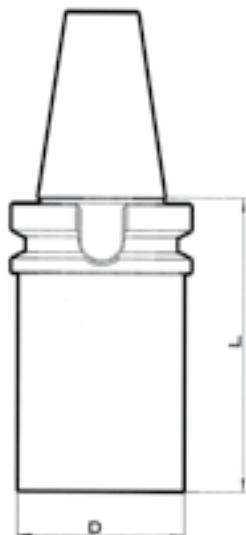

MAS 403 BT

CODICE CODE BESTELL NR CODE CÓDIGO	ATTACCO SHANK AUFNAHMEN ATTACHEMENT MANGO	D	L
1606.40.40BT	40	40,5	160
1606.63.40BT	40	63,5	160
1606.80.50BT	50	80	200

MANDRINI A CALETTAMENTO TERMICO



SCHRINK FIT CHUCKS
SCHRUMPFUTTER

MANDRINS DE FRETAGE
MANDRINOS DE DILATACIÓN TÉRMICA SHRINK FIT

Bilanciati G 2,5 - 15.000 giri/min

Balanced G 2,5 - 15.000 r.p.m.

Gewuchtet nach G 2,5 bei 15.000 U/mn.

Équilibré G 2,5 - 15.000 Tours/mn.

Equilibrado G 2,5 - 15.000 r.p.m.



MANDRINI A CALETTAMENTO TERMICO DIN 69871 AD+B

SCHRINK FIT CHUCK DIN 69871 AD+B

SCHRUMPFUTTER DIN 69871 AD+B

MANDRIN DE FRETTAGE DIN 69871 AD+B

MANDRINO SHRINK FIT DIN 69871 AD+B

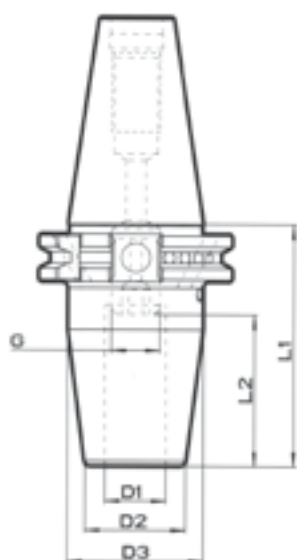

CODICE CODE BESTELL NR CODE CÓDIGO	ATTACCO SHANK AUFNAHMEN ATTACHEMENT MANGO	D1	D2	D3	L1	L2	G
ST060.0800-40A	40	6	21	27	80	36	M5
ST080.0800-40A	40	8	21	27	80	36	M6
ST100.0800-40A	40	10	24	32	80	42	M8
ST120.0800-40A	40	12	24	32	80	47	M10
ST140.0800-40A	40	14	27	34	80	47	M10
ST160.0800-40A	40	16	27	34	80	50	M12
ST180.0800-40A	40	18	33	42	80	50	M12
ST200.0800-40A	40	20	33	42	80	52	M16
ST250.1000-40A	40	25	44	53	100	58	M20
ST060.1000-50A	50	6	21	27	80	36	M5
ST080.1000-50A	50	8	21	27	80	36	M6
ST100.1000-50A	50	10	24	32	80	42	M8
ST120.1000-50A	50	12	24	32	80	47	M10
ST140.1000-50A	50	14	27	34	80	47	M10
ST160.1000-50A	50	16	27	34	80	50	M12
ST180.1000-50A	50	18	33	42	80	50	M12
ST200.1000-50A	50	20	33	42	80	52	M16
ST250.1000-50A	50	25	44	53	100	58	M20
ST320.1000-50A	50	32	44	53	100	58	M20

MANDRINI A CALETTAMENTO TERMICO DIN 69871 AD+B PROLUNGATI

EXTENDED SHRINK FIT CHUCK DIN 69871 AD+B
SCHRUMPFUTTER DIN 69871 AD+B VERLÄNGERT
MANDRIN DE FRETTAGE DIN 69871 AD+B ALLONGÉ
MANDRINO SHRINK FIT DIN 69871 AD+B EXTENDIDO

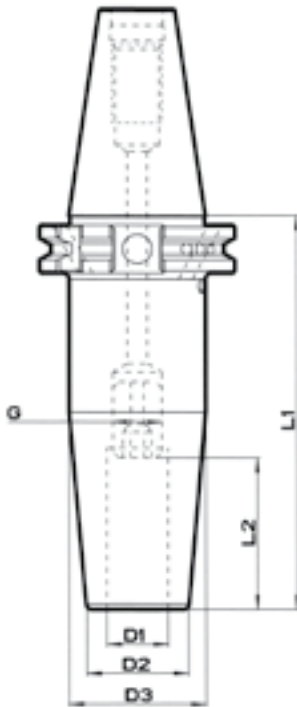

CODICE CODE BESTELL NR CODE CÓDIGO	ATTACCO SHANK AUFNAHMEN ATTACHEMENT MANGO	D1	D2	D3	L1	L2	G
Prolungati Extended Verlängerte Prolongé Extendido							
ST060.1600-40A	40	6	21	27	160	36	M5
ST080.1600-40A	40	8	21	27	160	36	M6
ST100.1600-40A	40	10	24	32	160	42	M8
ST120.1600-40A	40	12	24	32	160	47	M10
ST140.1600-40A	40	14	27	34	160	47	M10
ST160.1600-40A	40	16	27	34	160	50	M12
ST180.1600-40A	40	18	33	42	160	50	M12
ST200.1600-40A	40	20	33	42	160	52	M16
ST250.1600-40A	40	25	44	53	160	58	M20
ST060.1600-50A	50	6	21	27	160	36	M5
ST080.1600-50A	50	8	21	27	160	36	M6
ST100.1600-50A	50	10	24	32	160	42	M8
ST120.1600-50A	50	12	24	32	160	47	M10
ST140.1600-50A	50	14	27	34	160	47	M10
ST160.1600-50A	50	16	27	34	160	50	M12
ST180.1600-50A	50	18	33	42	160	50	M12
ST200.1600-50A	50	20	33	42	160	52	M16
ST250.1600-50A	50	25	44	53	160	58	M20
ST320.1600-50A	50	32	44	53	160	58	M20

MANDRINI A CALETTAMENTO TERMICO MAS 403 BT

SCHRINK FIT CHUCK MAS 403 BT

SCHRUMPFUTTER MAS 403 BT

MANDRIN DE FRETTAGE MAS 403 BT

MANDRINO SHRINK MAS 403 BT

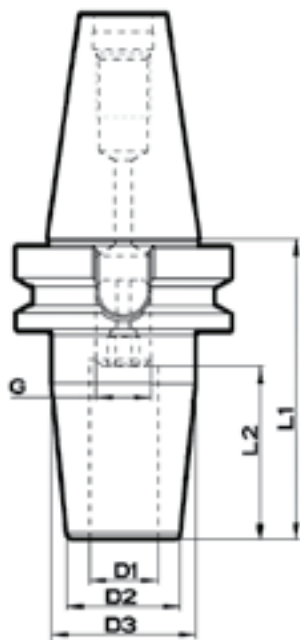

CODICE CODE BESTELL NR CODE CÓDIGO	ATTACCO SHANK AUFNAHMEN ATTACHEMENT MANGO	D1	D2	D3	L1	L2	G
ST060.0900-40BT	40	6	21	27	90	36	M5
ST080.0900-40BT	40	8	21	27	90	36	M6
ST100.0900-40BT	40	10	24	32	90	42	M8
ST120.0900-40BT	40	12	24	32	90	47	M10
ST140.0900-40BT	40	14	27	34	90	47	M10
ST160.0900-40BT	40	16	27	34	90	50	M12
ST180.0900-40BT	40	18	33	42	90	50	M12
ST200.0900-40BT	40	20	33	42	90	52	M16
ST250.1000-40BT	40	25	44	53	100	58	M20
ST060.0900-50BT	50	6	21	27	90	36	M5
ST080.0900-50BT	50	8	21	27	90	36	M6
ST100.0900-50BT	50	10	24	32	90	42	M8
ST120.0900-50BT	50	12	24	32	90	47	M10
ST140.0900-50BT	50	14	27	34	90	47	M10
ST160.0900-50BT	50	16	27	34	90	50	M12
ST180.0900-50BT	50	18	33	42	90	50	M12
ST200.0900-50BT	50	20	33	42	90	52	M16
ST250.1000-50BT	50	25	44	53	100	58	M20
ST320.1000-50BT	50	32	44	53	100	58	M20

MANDRINI A CALETTAMENTO TERMICO MAS 403 BT PROLUNGATI

EXTENDED SHRINK FIT CHUCK MAS 403 BT
SCHRUMPFUTTER MAS 403 BT VERLÄNGERT
MANDRIN DE FRETTAGE MAS 403 BT ALLONGÉ
MANDRINO SHRINK FIT MAS 403 BT EXTENDIDO

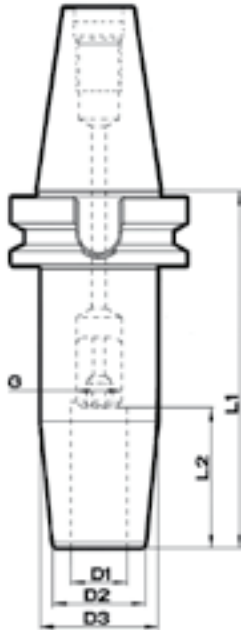

CODICE CODE BESTELL NR CODE CÓDIGO	ATTACCO SHANK AUFNAHMEN ATTACHEMENT MANGO	D1	D2	D3	L1	L2	G
ST060.1600-40BT	40	6	21	27	160	36	M5
ST080.1600-40BT	40	8	21	27	160	36	M6
ST100.1600-40BT	40	10	24	32	160	42	M8
ST120.1600-40BT	40	12	24	32	160	47	M10
ST140.1600-40BT	40	14	27	34	160	47	M10
ST160.1600-40BT	40	16	27	34	160	50	M12
ST180.1600-40BT	40	18	33	42	160	50	M12
ST200.1600-40BT	40	20	33	42	160	52	M16
ST250.1600-40BT	40	25	44	53	160	58	M20
ST060.1600-50BT	50	6	21	27	160	36	M5
ST080.1600-50BT	50	8	21	27	160	36	M6
ST100.1600-50BT	50	10	24	32	160	42	M8
ST120.1600-50BT	50	12	24	32	160	47	M10
ST140.1600-50BT	50	14	27	34	160	47	M10
ST160.1600-50BT	50	16	27	34	160	50	M12
ST180.1600-50BT	50	18	33	42	160	50	M12
ST200.1600-50BT	50	20	33	42	160	52	M16
ST250.1600-50BT	50	25	44	53	160	58	M20
ST320.1600-50BT	50	32	44	53	160	58	M20

MANDRINI A CALETTAMENTO TERMICO HSK DIN 69893

SCHRINK FIT CHUCK HSK DIN 69893

SCHRUMPFUTTER HSK DIN 69893

MANDRIN DE FRETTAGE HSK DIN 69893

MANDRINO SHRINK FIT HSK DIN 69893

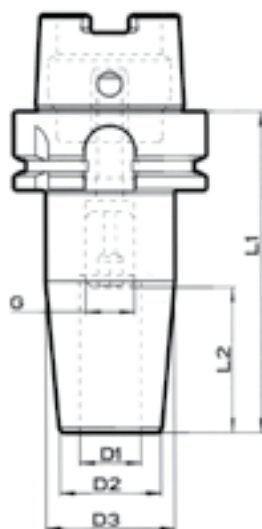

HSK - A+C

CODICE CODE BESTELL NR CODE CÓDIGO	ATTACCO SHANK AUFNAHMEN ATTACHEMENT MANGO	D1	D2	D3	L1	L2	G	Peso Weight Gewicht Poids Peso Kg
ST060.0800-H63A	HSK-63A	6	21	27	80	36	M5	1
ST080.0800-H63A	HSK-63A	8	21	27	80	36	M6	1
ST100.0850-H63A	HSK-63A	10	24	32	85	42	M8	1
ST120.0900-H63A	HSK-63A	12	24	32	90	47	M10	1
ST140.0900-H63A	HSK-63A	14	27	34	90	47	M10	1,3
ST160.0950-H63A	HSK-63A	16	27	34	95	50	M12	1,1
ST180.0950-H63A	HSK-63A	18	33	42	95	50	M12	1,2
ST200.1000-H63A	HSK-63A	20	33	42	100	52	M16	1,3
ST250.1150-H63A	HSK-63A	25	44	53	115	58	M20	1,8
ST320.1200-H63A	HSK-63A	32	44	53	120	58	M20	1,8
ST060.1000-H100A	HSK-100A	6	21	27	85	36	M5	1,3
ST080.1000-H100A	HSK-100A	8	21	27	85	36	M6	1,3
ST100.1000-H100A	HSK-100A	10	24	32	90	42	M8	1,3
ST120.1000-H100A	HSK-100A	12	24	32	95	47	M10	1,3
ST140.1000-H100A	HSK-100A	14	27	34	95	47	M10	1,3
ST160.1000-H100A	HSK-100A	16	27	34	100	50	M12	1,4
ST180.1000-H100A	HSK-100A	18	33	42	100	50	M12	1,6
ST200.1050-H100A	HSK-100A	20	33	42	105	52	M16	1,7
ST250.1150-H100A	HSK-100A	25	44	53	115	58	M20	2,2
ST320.1150-H100A	HSK-100A	32	44	53	120	58	M20	3

MANDRINI A CALETTAMENTO TERMICO HSK DIN 69893 PROLUNGATI

EXTENDED SHRINK FIT CHUCK HSK DIN 69893
SCHRUMPFUTTER HSK DIN 69893 VERLÄNGERT
MANDRIN DE FRETTAGE HSK DIN 69893 ALLONGÉ
MANDRINO SHRINK FIT HSK DIN 69893 EXTENDIDO

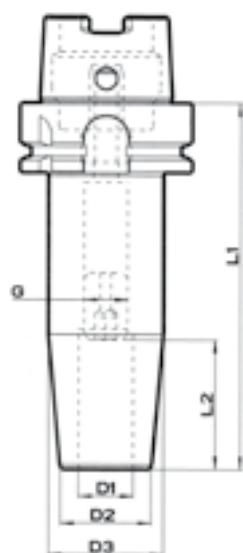

CODICE CODE BESTELL NR CODE CÓDIGO	ATTACCO SHANK AUFNAHMEN ATTACHEMENT MANGO	D1	D2	D3	L1	L2	G
Prolungati Extended Verlängerte Prolongé Extendido							
ST060.1600-H63A	HSK-63A	6	21	27	160	36	M5
ST080.1600-H63A	HSK-63A	8	21	27	160	36	M6
ST100.1600-H63A	HSK-63A	10	24	32	160	42	M8
ST120.1600-H63A	HSK-63A	12	24	32	160	47	M10
ST140.1600-H63A	HSK-63A	14	27	34	160	47	M10
ST160.1600-H63A	HSK-63A	16	27	34	160	50	M12
ST180.1600-H63A	HSK-63A	18	33	42	160	50	M12
ST200.1600-H63A	HSK-63A	20	33	42	160	52	M16
ST250.1600-H63A	HSK-63A	25	44	53	160	58	M20
ST060.1600-H100A	HSK-100A	6	21	27	160	36	M5
ST080.1600-H100A	HSK-100A	8	21	27	160	36	M6
ST100.1600-H100A	HSK-100A	10	24	32	160	42	M8
ST120.1600-H100A	HSK-100A	12	24	32	160	47	M10
ST140.1600-H100A	HSK-100A	14	27	34	160	47	M10
ST160.1600-H100A	HSK-100A	16	27	34	160	50	M12
ST180.1600-H100A	HSK-100A	18	33	42	160	50	M12
ST200.1600-H100A	HSK-100A	20	33	42	160	52	M16
ST250.1600-H100A	HSK-100A	25	44	53	160	58	M20
ST320.1600-H100A	HSK-100A	32	44	53	160	58	M20