

MANDRINI PORTA UTENSILI DIN 69871-AD + B

DIN 69871-AD + B TOOL HOLDERS WERKZEUGAUFNAHMEN DIN 69871-AD +B

PORTE-OUTILS DIN 69871-AD + B

PORTAHERRAMIENTAS DIN 69871-AD + B



PORTAFRESA A TRASCINAMENTO FISSO

UNIVERSAL MILLING CUTTER HOLDER

AUFSTECKFRAESERDORNE

PORTE FRAISE ENTRAINEMENT FIXE

PORTA FRESAS UNIVERSAL

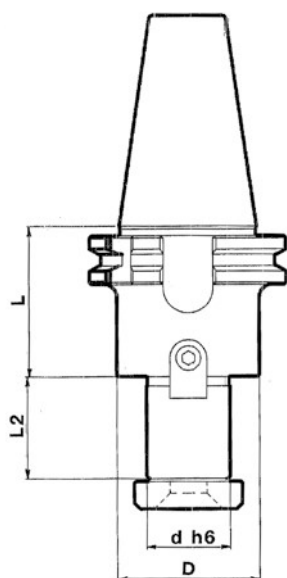

DIN 69871-AD + B

CODICE CODE BESTELL NR CODE CÓDIGO	ATTACCO SHANK AUFNAHMEN ATTACHEMENT MANGO	d	D	L2	L
1086.22.30A	30	22	48	19	35
2086.22.30A	30	22	48	19	60
1086.27.30A	30	27	58	21	50
2086.27.30A	30	27	58	21	60
2086.32.30A	30	32	58	24	60
1086.22.40A	40	22	48	19	45
3086.22.40A	40	22	48	19	100
1086.27.40A	40	27	58	21	50
3086.27.40A	40	27	58	21	100
1086.32.40A	40	32	78	24	55
2086.32.40A	40	32	78	24	100
1086.40.40A	40	40	88	27	55
2086.40.40A	40	40	88	27	100
2086.22.50A	50	22	48	19	60
3086.22.50A	50	22	48	19	100
2086.27.50A	50	27	58	21	60
3086.27.50A	50	27	58	21	100
1086.32.50A	50	32	78	24	50
2086.32.50A	50	32	78	24	100
1086.40.50A	50	40	88	27	60
2086.40.50A	50	40	88	27	100

PORTAPINZA A GRANDE CAPACITA' DI SERRAGGIO PER PINZE DIN 6499

COLLET CHUCK FOR DIN 6499 COLLETS
SPANNZANGENFUTTER DIN 6499
PORTE PINCES POUR PINCES DIN 6499
PORTA PINZAS DIN 6499

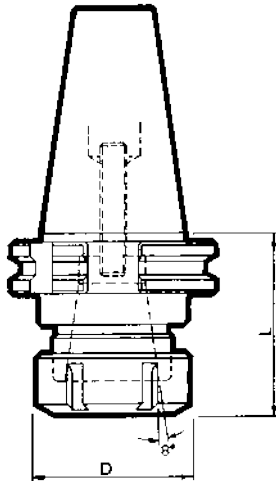

DIN 69871-AD + B

CODICE CODE BESTELL NR CODE CÓDIGO	ATTACCO SHANK AUFNAHMEN ATTACHEMENT MANGO	D	L	Pinze ER ER Collets Zangen ER Pincas ER Pinzas ER
1196.11.30AN	30	19	60	11
1196.16.30AN	30	28	60	16
1196.20.30AN	30	34	60	20
1196.25.30AN	30	42	60	25
1196.32.30AN	30	50	60	32
1196.11.40AN	40	19	70	11
1196.16.40AN	40	28	70	16
1196.20.40AN	40	34	70	20
1196.25.40AN	40	42	70	25
1196.32.40AN	40	50	70	32
1196.40.40AN	40	63	80	40
1196.16.50AN	50	28	70	16
1196.20.50AN	50	34	70	20
1196.25.50AN	50	42	70	25
1196.32.50AN	50	50	70	32
1196.40.50AN	50	63	80	40

Per utensili con gambo cilindrico.

For cylindrical shank tools.

Zur Aufnahme von Werkzeugen mit Zylinderschaft in Spannzangen.

Pour outils avec queue cylindrique

Para herramientas de mango cilíndrico

PORTAPINZA A GRANDE CAPACITA' DI SERRAGGIO PER PINZE DIN 6499

COLLET CHUCK FOR DIN 6499 COLLETS
SPANNZANGENFUTTER DIN 6499
PORTE PINCES POUR PINCES DIN 6499
PORTA PINZAS DIN 6499

DIN 69871-AD + B

CODICE CODE BESTELL NR CODE CÓDIGO	ATTACCO SHANK AUFNAHMEN ATTACHEMENT MANGO	D	L	Pinze ER ER Collets Zangen ER Pinces ER Pinzas ER
Prolungati Extended Verlängerte Prolongé Extendido				
2196.11.30AN	30	19	100	11
2196.16.30AN	30	28	100	16
2196.20.30AN	30	34	100	20
2196.25.30AN	30	42	100	25
2196.32.30AN	30	50	100	32
2196.11.40AN	40	19	100	11
2196.16.40AN	40	28	100	16
3196.16.40AN	40	28	150	16
2196.20.40AN	40	34	100	20
3196.20.40AN	40	34	150	20
2196.25.40AN	40	42	100	25
3196.25.40AN	40	42	150	25
2196.32.40AN	40	50	100	32
3196.32.40AN	40	50	150	32
2196.40.40AN	40	63	100	40
3196.40.40AN	40	63	150	40
2196.16.50AN	50	28	100	16
3196.16.50AN	50	28	150	16
2196.20.50AN	50	34	100	20
3196.20.50AN	50	34	150	20
2196.25.50AN	50	42	100	25
3196.25.50AN	50	42	150	25
2196.32.50AN	50	50	100	32
3196.32.50AN	50	50	150	32
2196.40.50AN	50	63	100	40
3196.40.50AN	50	63	150	40
4196.40.50AN	50	63	200	40

Per utensili con gambo cilindrico.

Ring nut for cylindrical shank tools.

Zur Aufnahme von Werkzeugen mit Zylinderschaft in Spannzangen.

Pour outils avec queue cylindrique.

Tuerca de anillo para herramientas de mango cilíndrico

PORTAFRESA WELDON

END MILL HOLDER WELDON
FRÄSERSPANNFUTTER WELDON
MANDRIN PORTE FRAISES À QUEUE WELDON
PORTAFRESAS TIPO WELDON

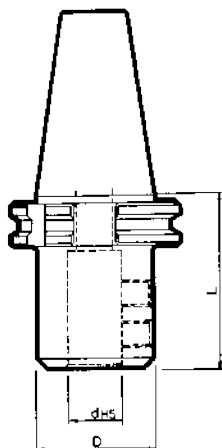

DIN 69871-AD + B

CODICE CODE BESTELL NR CODE CÓDIGO	ATTACCO SHANK AUFNAHMEN ATTACHEMENT MANGO	d	D	L
1246.06.30A	30	6	25	50
1246.08.30A	30	8	28	50
1246.10.30A	30	10	35	50
1246.12.30A	30	12	42	50
1246.16.30A	30	16	48	63
1246.20.30A	30	20	52	63
1246.06.40A	40	6	25	50
2246.06.40A	40	6	25	100
3246.06.40A	40	6	25	160
4246.06.40A	40	6	25	200
1246.08.40A	40	8	28	50
2246.08.40A	40	8	28	100
3246.08.40A	40	8	28	160
4246.08.40A	40	8	28	200
1246.10.40A	40	10	35	50
2246.10.40A	40	10	35	100
3246.10.40A	40	10	35	160
4246.10.40A	40	10	35	200
1246.12.40A	40	12	42	50
2246.12.40A	40	12	42	100
3246.12.40A	40	12	42	160
4246.12.40A	40	12	42	200

For Weldon end mill with cylindrical shank DIN 1835

Zum Spannen von zylindrischen Werkzeugschaften nach DIN 1835

Pour fraises avec attachement cylindrique DIN 1835

Para fresa de mango cilíndrico con weldon DIN 1835

PORTAFRESA WELDON

END MILL HOLDER WELDON

FRÄSERSPANNFUTTER WELDON

MANDRIN PORTE FRAISES À QUEUE WELDON

PORTAFRESAS TIPO WELDON

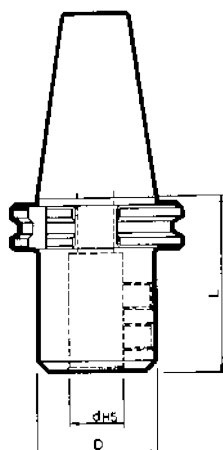

DIN 69871-AD + B

CODICE CODE BESTELL NR CODE CÓDIGO	ATTACCO SHANK AUFNAHMEN ATTACHEMENT MANGO	d	D	L
1246.16.40A	40	16	48	63
2246.16.40A	40	16	48	100
3246.16.40A	40	16	48	160
4246.16.40A	40	16	48	200
1246.20.40A	40	20	52	63
2246.20.40A	40	20	52	100
3246.20.40A	40	20	52	160
4246.20.40A	40	20	52	200
1246.25.40A	40	25	65	100
2246.25.40A	40	25	65	160
3246.25.40A	40	25	65	200
1246.32.40A	40	32	72	100
2246.32.40A	40	32	72	160
1246.06.50A	50	6	25	63
2246.06.50A	50	6	25	100
3246.06.50A	50	6	25	160
4246.06.50A	50	6	25	200
1246.08.50A	50	8	28	63
2246.08.50A	50	8	28	100
3246.08.50A	50	8	28	160
4246.08.50A	50	8	28	200

PORTAFRESA WELDON

END MILL HOLDER WELDON
FRÄSERSPANNFUTTER WELDON
MANDRIN PORTE FRAISES À QUEUE WELDON
PORTAFRESAS TIPO WELDON

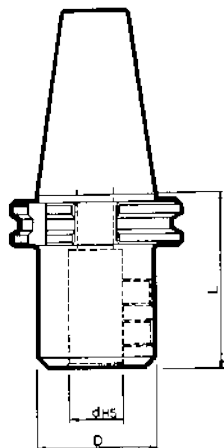

DIN 69871-AD + B

CODICE CODE BESTELL NR CODE CÓDIGO	ATTACCO SHANK AUFNAHMEN ATTACHEMENT MANGO	d	D	L
1246.10.50A	50	10	35	63
2246.10.50A	50	10	35	100
3246.10.50A	50	10	35	160
4246.10.50A	50	10	35	200
1246.12.50A	50	12	42	63
2246.12.50A	50	12	42	100
3246.12.50A	50	12	42	160
4246.12.50A	50	12	42	200
1246.16.50A	50	16	48	63
2246.16.50A	50	16	48	100
3246.16.50A	50	16	48	160
4246.16.50A	50	16	48	200
1246.20.50A	50	20	52	63
2246.20.50A	50	20	52	100
3246.20.50A	50	20	52	160
4246.20.50A	50	20	52	200
1246.25.50A	50	25	65	80
2246.25.50A	50	25	65	120
3246.25.50A	50	25	65	160
1246.32.50A	50	32	72	100
3246.32.50A	50	32	72	160
1246.40.50A	50	40	90	100
2246.40.50A	50	40	90	160

RIDUZIONI A CONO MORSE PER PUNTE DIN 228-B

MORSE TAPER ADAPTER FOR TWIST DRILLS DIN 228-B

ZWISCHENHULSEN FÜR BOHRER DIN 228-B

REDUCTION CONE MORSE POUR FORETS DIN 228-B

ADAPTADOR CONO MORSE PARA BROCCAS DIN 228-B

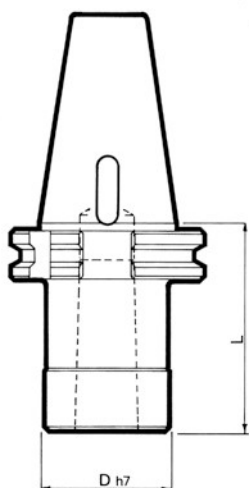

DIN 69871-AD

CODICE CODE BESTELL NR CODE CÓDIGO	ATTACCO SHANK AUFNAHMEN ATTACHEMENT MANGO	Cono Morse Morse cone Innenkegel Cone Morse Cono Morse	D	L
1306.01.30A	30	1	25	50
1306.02.30A	30	2	32	60
1306.03.30A	30	3	40	75
1306.01.40A	40	1	25	50
1306.02.40A	40	2	32	50
1306.03.40A	40	3	40	70
1306.04.40A	40	4	48	95
1306.01.50A	50	1	25	45
1306.02.50A	50	2	32	60
1306.03.50A	50	3	40	65
1306.04.50A	50	4	48	95
1306.05.50A	50	5	63	105

RIDUZIONE A CONO MORSE PER FRESE DIN 228-A

MORSE TAPER ADAPTER FOR MILLING CUTTERS DIN 228-A
ZWISCHENHULSEN FÜR FRÄSER DIN 228-A
REDUCTION CONE MORSE POUR FRAISES DIN 228-A
ADAPTADOR CONO MORSE PARA FRESAS DIN 228-A

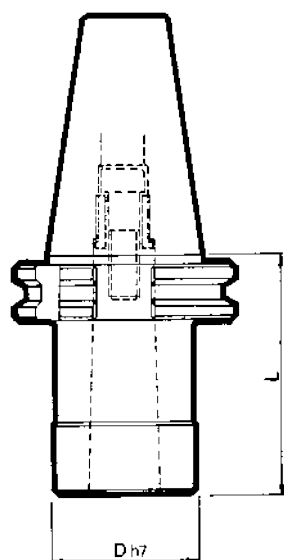

DIN 69871-AD

CODICE CODE BESTELL NR CODE CÓDIGO	ATTACCO SHANK AUFNAHMEN ATTACHEMENT MANGO	Cono Morse Morse cone Innenkegel Cone Morse Cono Morse	D	L
1336.01.30A	30	1	25	45
1336.02.30A	30	2	32	60
1336.03.30A	30	3	40	80
1336.01.40A	40	1	25	45
1336.02.40A	40	2	32	60
1336.03.40A	40	3	40	75
1336.04.40A	40	4	48	95
1336.01.50A	50	1	25	45
1336.02.50A	50	2	32	60
1336.03.50A	50	3	40	75
1336.04.50A	50	4	48	95
1336.05.50A	50	5	63	120

ATTACCO PER MANDRINI PORTAPUNTE DIN 238

CHUCK DRILL HOLDER DIN 238

BOHRFUTTERAUFNAHMEN DIN 238

ATTACHEMENT POUR MANDRINS DE PERCAGE DIN 238

CONO PORTA BROCAS DIN 238

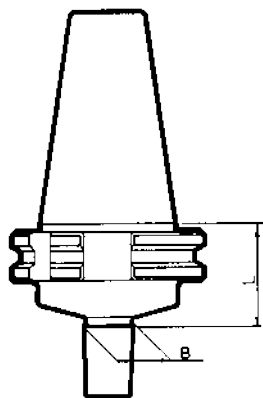

DIN 69871-A

CODICE CODE BESTELL NR CODE CÓDIGO	ATTACCO SHANK AUFNAHMEN ATTACHEMENT MANGO	DIN 238	B	L
1576.12.30A	30	B12	12,07	40
1576.16.30A	30	B16	15,73	40
*1576.12.40A	40	B12	12,07	40
1576.16.40A	40	B16	15,73	40
1576.18.40A	40	B18	17,78	40
1576.16.50A	50	B16	15,73	50
1576.18.50A	50	B18	17,78	50

* **Fino ad esaurimento scorte**

Subject to the selling out

Bis zum restlosen Ausverkauf der Ware

Jusqu'à épuisement du stock

Hasta el final de existencias almacén

BARRE A STELO TENERO

BLANK TOOL-HOLDER
ROHLINGE ZUR BEARBEITUNG VON SONDERAUSFÜHRUNGEN
BARRES D'ALEPAGE SEMI-FINIES
BARRAS CON MANGO BLANDO

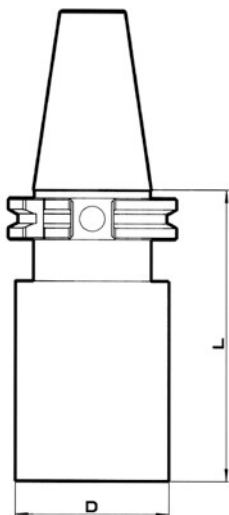

DIN 69871-A

CODICE CODE BESTELL NR CODE CÓDIGO	ATTACCO SHANK AUFNAHMEN ATTACHEMENT MANGO	D	L
2606.63.40A	40	63	250
2606.97.50A	50	97	315

Blank < 30 HRC



MANDRINI PORTA UTENSILI MAS 403 BT

MAS 403 BT TOOL HOLDERS
WERKZEUGAUFNAHMEN MAS 403 BT

PORTE-OUTILS MAS 403 BT
PORTAHERRAMIENTAS MAS 403 BT



PORTAFRESA A TRASCINAMENTO FISSO

UNIVERSAL MILLING CUTTER HOLDER
 AUFSTECKFRAESERDORNE
 PORTE FRAISE ENTRAINEMENT FIXE
 PORTA FRESAS UNIVERSAL

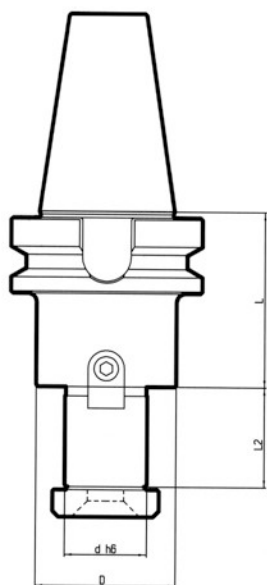

MAS 403 BT

CODICE CODE BESTELL NR CODE CÓDIGO	ATTACCO SHANK AUFNAHMEN ATTACHEMENT MANGO	d	D	L2	L
1086.22.30BT	30	22	48	19	35
2086.22.30BT	30	22	48	19	60
1086.27.30BT	30	27	58	21	40
2086.27.30BT	30	27	58	21	60
1086.32.30BT	30	32	58	22	60
1086.22.40BT	40	22	48	19	45
3086.22.40BT	40	22	48	19	100
1086.27.40BT	40	27	58	21	45
3086.27.40BT	40	27	58	21	100
1086.32.40BT	40	32	78	24	60
2086.32.40BT	40	32	78	24	100
1086.40.40BT	40	40	88	27	55
2086.40.40BT	40	40	88	27	100
1086.22.50BT	50	22	48	19	60
2086.22.50BT	50	22	48	19	100
1086.27.50BT	50	27	58	21	60
2086.27.50BT	50	27	58	21	100
1086.32.50BT	50	32	78	24	60
2086.32.50BT	50	32	78	24	100
1086.40.50BT	50	40	88	27	60
2086.40.50BT	50	40	88	27	100

PORTAPINZA A GRANDE CAPACITÀ DI SERRAGGIO PER PINZE DIN 6499

COLLET CHUCK FOR DIN 6499 COLLETS
SPANNZANGENFUTTER DIN 6499
PORTE PINCES POUR PINCES DIN 6499
PORTA PINZAS DIN 6499

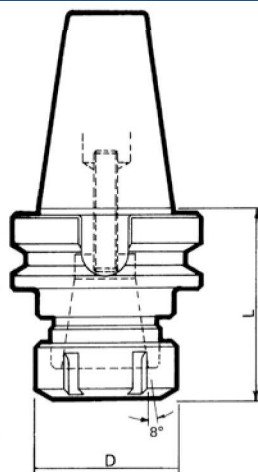

MAS 403 BT

CODICE CODE BESTELL NR CODE CÓDIGO	ATTACCO SHANK AUFNAHMEN ATTACHEMENT MANGO	D	L	Pinze ER ER Collets Zangen ER Pinces ER Pinzas ER
1196.11.30BTN	30	19	60	11
1196.16.30BTN	30	28	60	16
1196.20.30BTN	30	34	60	20
1196.25.30BTN	30	42	60	25
1196.32.30BTN	30	50	60	32
1196.11.40BTN	40	19	70	11
1196.16.40BTN	40	28	70	16
1196.20.40BTN	40	34	70	20
1196.25.40BTN	40	42	70	25
1196.32.40BTN	40	50	70	32
1196.40.40BTN	40	63	80	40
1196.16.50BTN	50	28	70	16
1196.20.50BTN	50	34	70	20
1196.25.50BTN	50	42	70	25
1196.32.50BTN	50	50	70	32
1196.40.50BTN	50	63	80	40

PORTAPINZA A GRANDE CAPACITA' DI SERRAGGIO PER PINZE DIN 6499

COLLET CHUCK FOR DIN 6499 COLLETS

SPANNZANGENFUTTER DIN 6499

PORTE PINCES POUR PINCES DIN 6499

PORTA PINZAS DIN 6499

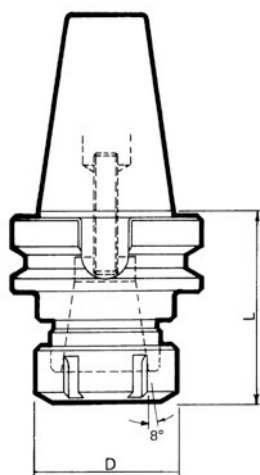

MAS 403 BT

CODICE CODE BESTELL NR CODE CÓDIGO	ATTACCO SHANK AUFNAHMEN ATTACHEMENT MANGO	D	L	Pinze ER ER Collets Zangen ER Pinces ER Pinzas ER
Prolungati Extended Verlängerte Prolongé Extendido				
2196.11.30BTN	30	19	100	11
2196.16.30BTN	30	28	100	16
2196.20.30BTN	30	34	100	20
2196.25.30BTN	30	42	100	25
2196.32.30BTN	30	50	100	32
2196.11.40BTN	40	19	100	11
2196.16.40BTN	40	28	100	16
3196.16.40BTN	40	28	150	16
2196.20.40BTN	40	34	100	20
3196.20.40BTN	40	34	150	20
2196.25.40BTN	40	42	100	25
3196.25.40BTN	40	42	150	25
2196.32.40BTN	40	50	100	32
3196.32.40BTN	40	50	150	32
2196.40.40BTN	40	63	100	40
3196.40.40BTN	40	63	150	40

Per utensili con gambo cilindrico.

For cylindrical shank tools.

Zur Aufnahme von Werkzeugen mit Zylinderschaft in Spannzangen.

Pour outils avec queue cylindrique

Para herramientas de mango cilíndrico

PORTAPINZA A GRANDE CAPACITA' DI SERRAGGIO PER PINZE DIN 6499

COLLET CHUCK FOR DIN 6499 COLLETS
SPANNZANGENFUTTER DIN 6499
PORTE PINCES POUR PINCES DIN 6499
PORTA PINZAS DIN 6499

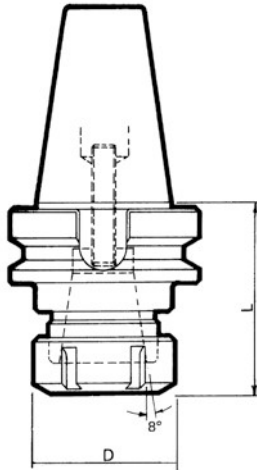

MAS 403 BT

CODICE CODE BESTELL NR CODE CÓDIGO	ATTACCO SHANK AUFNAHMEN ATTACHEMENT MANGO	D	L	Pinze ER ER Collets Zangen ER Pinces ER Pinzas ER
Prolungati Extended Verlängerte Prolongé Extendido				
2196.16.50BTN	50	28	100	16
3196.16.50BTN	50	28	150	16
2196.20.50BTN	50	34	100	20
3196.20.50BTN	50	34	150	20
2196.25.50BTN	50	42	100	25
3196.25.50BTN	50	42	150	25
2196.32.50BTN	50	50	100	32
3196.32.50BTN	50	50	150	32
2196.40.50BTN	50	63	100	40
3196.40.50BTN	50	63	150	40
4196.40.50BTN	50	63	200	40

PORTAFRESA WELDON

END MILL HOLDER WELDON
FRÄSERSPANNFUTTER WELDON
MANDRIN PORTE FRAISES À QUEUE WELDON
PORTAFRESAS TIPO WELDON

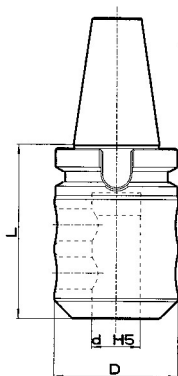

MAS 403 BT

CODICE CODE BESTELL NR CODE CÓDIGO	ATTACCO SHANK AUFNAHMEN ATTACHEMENT MANGO	d	D	L
1246.06.30BT	30	6	25	60
1246.08.30BT	30	8	28	60
1246.10.30BT	30	10	35	60
1246.12.30BT	30	12	42	60
1246.16.30BT	30	16	48	75
2246.20.30BT	30	20	52	75
1246.25.30BT	30	25	65	80
2246.25.30BT	30	25	65	90
1246.06.40BT	40	6	25	50
2246.06.40BT	40	6	25	100
3246.06.40BT	40	6	25	160
4246.06.40BT	40	6	25	200
1246.08.40BT	40	8	28	50
2246.08.40BT	40	8	28	100
3246.08.40BT	40	8	28	160
4246.08.40BT	40	8	28	200
1246.10.40BT	40	10	35	63
2246.10.40BT	40	10	35	100
3246.10.40BT	40	10	35	160
4246.10.40BT	40	10	35	200
1246.12.40BT	40	12	42	63
2246.12.40BT	40	12	42	100
3246.12.40BT	40	12	42	160
4246.12.40BT	40	12	42	200

For Weldon end mill with cylindrical shank DIN 1835
Zum Spannen von zylindrischen Werkzeugschaften nach DIN 1835
Pour fraises avec attachement cylindrique DIN 1835
Para fresa de mango cilíndrico con weldon DIN 1835

PORTAFRESA WELDON

END MILL HOLDER WELDON
FRÄSERSPANNFUTTER WELDON
MANDRIN PORTE FRAISES À QUEUE WELDON
PORTAFRESAS TIPO WELDON



MAS 403 BT

CODICE CODE BESTELL NR CODE CÓDIGO	ATTACCO SHANK AUFNAHMEN ATTACHEMENT MANGO	d	D	L
1246.16.40BT	40	16	48	63
2246.16.40BT	40	16	48	100
3246.16.40BT	40	16	48	160
4246.16.40BT	40	16	48	200
1246.20.40BT	40	20	52	63
2246.20.40BT	40	20	52	100
3246.20.40BT	40	20	52	160
4246.20.40BT	40	20	52	200
1246.25.40BT	40	25	65	100
2246.25.40BT	40	25	65	160
3246.25.40BT	40	25	65	200
1246.32.40BT	40	32	72	100
2246.32.40BT	40	32	72	160
1246.40.40BT	40	40	80	105

For Weldon end mill with cylindrical shank DIN 1835

Zum Spannen von zylindrischen Werkzeugschaften nach DIN 1835

Pour fraises avec attachement cylindrique DIN 1835

Para fresa de mango cilíndrico con weldon DIN 1835

PORTAFRESA WELDON

END MILL HOLDER WELDON

FRÄSERSPANNFUTTER WELDON

MANDRIN PORTE FRAISES À QUEUE WELDON

PORTAFRESAS TIPO WELDON

MAS 403 BT

CODICE CODE BESTELL NR CODE CÓDIGO	ATTACCO SHANK AUFNAHMEN ATTACHEMENT MANGO	d	D	L
1246.06.50BT	50	6	25	63
2246.06.50BT	50	6	25	100
3246.06.50BT	50	6	25	160
4246.06.50BT	50	6	25	200
1246.08.50BT	50	8	28	63
2246.08.50BT	50	8	28	100
3246.08.50BT	50	8	28	160
4246.08.50BT	50	8	28	200
1246.10.50BT	50	10	35	63
2246.10.50BT	50	10	35	100
3246.10.50BT	50	10	35	160
4246.10.50BT	50	10	35	200
1246.12.50BT	50	12	42	80
2246.12.50BT	50	12	42	100
3246.12.50BT	50	12	42	160
4246.12.50BT	50	12	42	200
1246.16.50BT	50	16	48	80
2246.16.50BT	50	16	48	100
3246.16.50BT	50	16	48	160
4246.16.50BT	50	16	48	200
1246.20.50BT	50	20	52	80
2246.20.50BT	50	20	52	100
3246.20.50BT	50	20	52	160
4246.20.50BT	50	20	52	200
1246.25.50BT	50	25	65	100
2246.25.50BT	50	25	65	160
1246.32.50BT	50	32	72	105
2246.32.50BT	50	32	72	160
1246.40.50BT	50	40	80	115



For Weldon end mill with cylindrical shank DIN 1835
Zum Spannen von zylindrischen Werkzeugschaften nach DIN 1835
Pour fraises avec attachement cylindrique DIN 1835
Para fresa de mango cilíndrico con weldon DIN 1835

RIDUZIONI A CONO MORSE PER PUNTE DIN 228-B

MORSE TAPER ADAPTER FOR TWIST DRILLS DIN 228-B
ZWISCHENHULSEN FÜR BOHRER DIN 228-B
REDUCTION CONE MORSE POUR FORETS DIN 228-B
ADAPTADOR CONO MORSE PARA BROCAS DIN 228-B

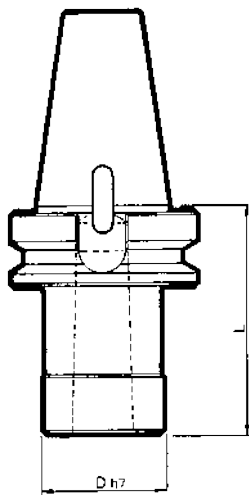

MAS 403 BT

CODICE CODE BESTELL NR CODE CÓDIGO	ATTACCO SHANK AUFNAHMEN ATTACHEMENT MANGO	Cono Morse Morse cone Innenkegel Cone Morse Cono Morse	D	L
1306.01.30BT	30	1	25	45
1306.02.30BT	30	2	32	60
1306.03.30BT	30	3	40	80
1306.01.40BT	40	1	25	45
1306.02.40BT	40	2	32	60
1306.03.40BT	40	3	40	75
1306.04.40BT	40	4	48	95
1306.01.50BT	50	1	25	45
1306.02.50BT	50	2	32	60
1306.03.50BT	50	3	40	75
1306.04.50BT	50	4	48	90
1306.05.50BT	50	5	63	110

RIDUZIONE A CONO MORSE PER FRESE DIN 228-A

MORSE TAPER ADAPTER FOR MILLING CUTTERS DIN 228-A

ZWISCHENHULSEN FÜR FRÄSER DIN 228-A

REDUCTION CONE MORSE POUR FRAISES DIN 228-A

ADAPTADOR CONO MORSE PARA FRESAS DIN 228-A

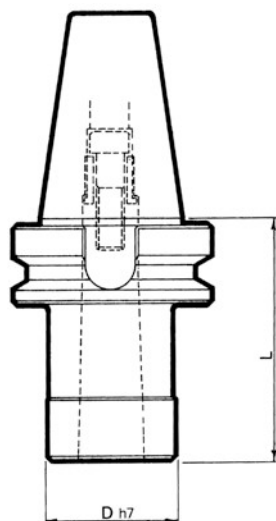

MAS 403 BT

CODICE CODE BESTELL NR CODE CÓDIGO	ATTACCO SHANK AUFNAHMEN ATTACHEMENT MANGO	Cono Morse Morse cone Innenkegel Cone Morse Cono Morse	D	L
1336.01.30BT	30	1	25	45
1336.02.30BT	30	2	32	60
1336.03.30BT	30	3	40	80
1336.01.40BT	40	1	25	45
1336.02.40BT	40	2	32	60
1336.03.40BT	40	3	40	75
1336.04.40BT	40	4	48	95
1336.01.50BT	50	1	25	45
1336.02.50BT	50	2	32	60
1336.03.50BT	50	3	40	75
1336.04.50BT	50	4	48	90
1336.05.50BT	50	5	63	110

ATTACCO PER MANDRINI PORTAPUNTE DIN 238

CHUCK DRILL HOLDER DIN 238
BOHRFUTTERAUFNAHMEN DIN 238
ATTACHEMENT POUR MANDRINS DE PERCAGE DIN 238
CONO PORTA BROCAS DIN 238

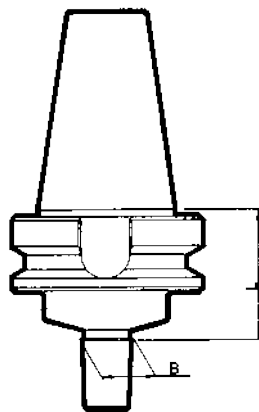

MAS 403 BT

CODICE CODE BESTELL NR CODE CÓDIGO	ATTACCO SHANK AUFNAHMEN ATTACHEMENT MANGO	DIN 238	B	L
1576.12.30BT	30	B12	12	40
1576.16.30BT	30	B16	16	40
* 1576.12.40BT	40	B12	12	40
1576.16.40BT	40	B16	16	40
1576.18.40BT	40	B18	18	40
1576.16.50BT	50	B16	16	50
1576.18.50BT	50	B18	18	50

* **Fino ad esaurimento scorte**
Subject to the selling out
Bis zum restlosen Ausverkauf der Ware
Jusqu'à épuisement du stock
Hasta el final de existencias almacén

BARRE A STELO TENERO

BLANK TOOL-HOLDER

ROHLINGE ZUR BEARBEITUNG VON SONDERAUSFÜHRUNGEN

BARRES D'ALEPAGE SEMI-FINIES

BARRAS CON MANGO BLANDO

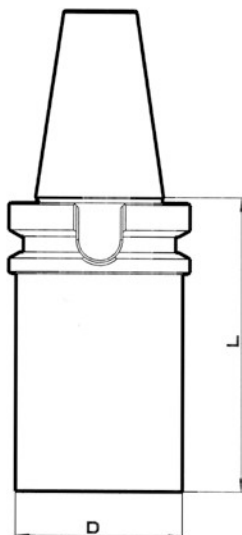

MAS 403 BT

CODICE CODE BESTELL NR CODE CÓDIGO	ATTACCO SHANK AUFNAHMEN ATTACHEMENT MANGO	D	L
2606.63.40BT	40	63	250
2606.97.50BT	50	97	315

Blank < 30 HRC

MANDRINI PORTA UTENSILI DIN 2080

DIN 2080 TOOL HOLDERS
WERKZEUGAUFNAHMEN DIN 2080

PORTE-OUTILS DIN 2080
PORTAHERRAMIENTAS DIN 2080



PORTAFRESA A TRASCINAMENTO FISSO

UNIVERSAL MILLING CUTTER HOLDER
AUFSTECKFRAESERDORNE
PORTE FRAISE ENTRAINEMENT FIXE
PORTA FRESAS UNIVERSAL

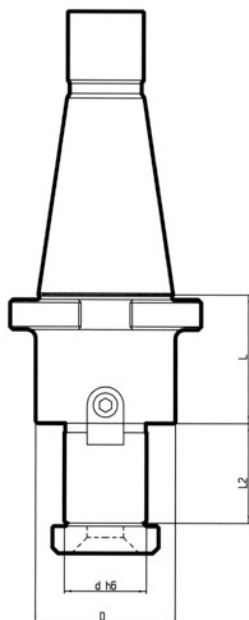

DIN 2080

CODICE CODE BESTELL NR CODE CÓDIGO	ATTACCO SHANK AUFNAHMEN ATTACHEMENT MANGO	d	D	L2	L
1086.16.40	40	16	38	17	45
1086.22.40	40	22	48	19	45
1086.27.40	40	27	58	21	45
1086.32.40	40	32	78	24	50
1086.40.40	40	40	88	27	55
1086.16.50	50	16	38	17	45
1086.22.50	50	22	48	19	45
1086.27.50	50	27	58	21	45
1086.32.50	50	32	78	24	50
1086.40.50	50	40	88	27	50

PORTAPINZA A GRANDE CAPACITA' DI SERRAGGIO PER PINZE DIN 6499

COLLET CHUCK FOR DIN 6499 COLLETS
SPANNZANGENFUTTER DIN 6499
PORTE PINCES POUR PINCES DIN 6499
PORTA PINZAS DIN 6499

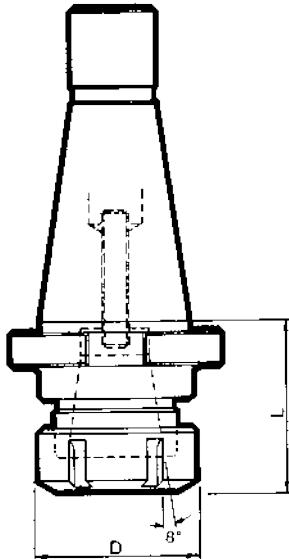

DIN 2080

CODICE CODE BESTELL NR CODE CÓDIGO	ATTACCO SHANK AUFNAHMEN ATTACHEMENT MANGO	D	L	Pinze ER ER Collets Zangen ER Pinces ER Pinzas ER
1196.25.40N	40	42	53	25
1196.32.40N	40	50	68	32
1196.40.40N	40	63	80	40
1196.32.50N	50	50	68	32
1196.40.50N	50	63	76	40
Prolungati Extended Verlängerte Prolongé Extendido				
* 3196.16.40N	40	28	150	16
2196.32.40N	40	50	110	32
* 2196.16.50N	50	28	100	16
* 3196.16.50N	50	28	150	16
2196.32.50N	50	50	140	32
2196.40.50N	50	63	140	40

* **Fino ad esaurimento scorte**
Subject to the selling out
Bis zumrestlosen Ausverkauf der Ware
Jusqu'à épuisement du stock
Hasta el final de existencias almacén

Per utensili con gambo cilindrico.

For cylindrical shank tools.

Zur Aufnahme von Werkzeugen mit Zylinderschaft in Spannzangen.

Pour outils avec queue cylindrique

Para herramientas de mango cilíndrico

PORTAFRESA WELDON

END MILL HOLDER WELDON

FRÄSERSPANNFUTTER WELDON

MANDRIN PORTE FRAISES À QUEUE WELDON

PORTAFRESAS TIPO WELDON

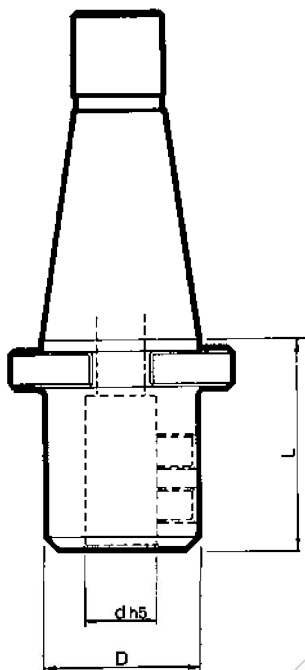

DIN 2080

CODICE CODE BESTELL NR CODE CÓDIGO	ATTACCO SHANK AUFNAHMEN ATTACHEMENT MANGO	d	D	L
1246.06.40	40	6	25	50
1246.08.40	40	8	28	50
1246.10.40	40	10	35	50
1246.12.40	40	12	42	50
1246.16.40	40	16	48	63
1246.20.40	40	20	52	63
1246.25.40	40	25	65	90
1246.32.40	40	32	72	90
1246.06.50	50	6	25	50
1246.08.50	50	8	28	50
1246.10.50	50	10	35	63
1246.12.50	50	12	42	63
1246.16.50	50	16	48	63
1246.20.50	50	20	52	63
1246.25.50	50	25	65	80
1246.32.50	50	32	72	85
1246.40.50	50	40	78	95

For Weldon end mill with cylindrical shank DIN 1835

Zum Spannen von zylindrischen Werkzeugschaften nach DIN 1835

Pour fraises avec attachement cylindrique DIN 1835

Para fresa de mango cilíndrico con weldon DIN 1835

RIDUZIONI A CONO MORSE PER PUNTE DIN 228-B

MORSE TAPER ADAPTER FOR TWIST DRILLS DIN 228-B
ZWISCHENHULSEN FÜR BOHRER DIN 228-B
REDUCTION CONE MORSE POUR FORETS DIN 228-B
ADAPTADOR CONO MORSE PARA BROCAS DIN 228-B

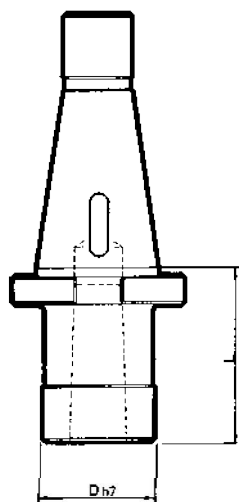

DIN 2080

CODICE CODE BESTELL NR CODE CÓDIGO	ATTACCO SHANK AUFNAHMEN ATTACHEMENT MANGO	Cono Morse Morse cone Innenkegel Cone Morse Cono Morse	D	L
1306.01.40	40	1	25	50
1306.02.40	40	2	32	50
1306.03.40	40	3	40	65
1306.04.40	40	4	48	95
1306.01.50	50	1	25	45
1306.02.50	50	2	32	60
1306.03.50	50	3	40	65
1306.04.50	50	4	48	70
1306.05.50	50	5	63	105

For Weldon end mill with cylindrical shank DIN 1835
Zum Spannen von zylindrischen Werkzeugschaften nach DIN 1835
Pour fraises avec attachement cylindrique DIN 1835
Para fresa de mango cilíndrico con weldon DIN 1835

RIDUZIONE A CONO MORSE PER FRESE DIN 228-A

MORSE TAPER ADAPTER FOR MILLING CUTTERS DIN 228-A

ZWISCHENHULSEN FÜR FRÄSER DIN 228-A

REDUCTION CONE MORSE POUR FRAISES DIN 228-A

ADAPTADOR CONO MORSE PARA FRESAS DIN 228-A

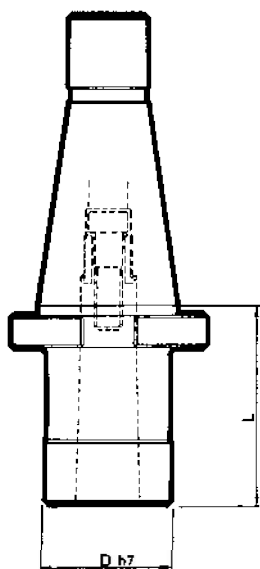

DIN 2080

CODICE CODE BESTELL NR CODE CÓDIGO	ATTACCO SHANK AUFNAHMEN ATTACHEMENT MANGO	Cono Morse Morse cone Innenkegel Cone Morse Cono Morse	D	L
1336.01.40	40	1	25	50
1336.02.40	40	2	32	50
1336.03.40	40	3	40	65
1336.04.40	40	4	48	95
1336.01.50	50	1	25	45
1336.02.50	50	2	32	60
1336.03.50	50	3	40	65
1336.04.50	50	4	48	65
1336.05.50	50	5	63	120

ATTACCO PER MANDRINI PORTAPUNTE DIN 238

CHUCK DRILL HOLDER DIN 238
BOHRFUTTERAUFNAHMEN DIN 238
ATTACHEMENT POUR MANDRINS DE PERCAGE DIN 238
CONO PORTA BROCAS DIN 238

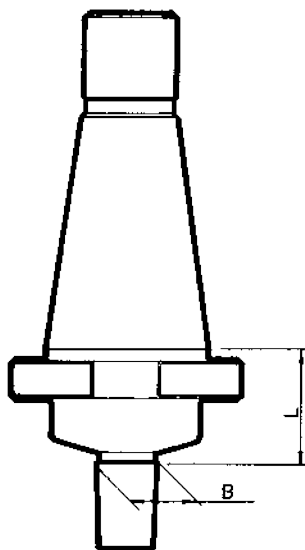

DIN 2080

CODICE CODE BESTELL NR CODE CÓDIGO	ATTACCO SHANK AUFNAHMEN ATTACHEMENT MANGO	DIN 238	B	L
* 1576.12.40	40	B12	12,07	25
1576.16.40	40	B16	15,73	17
1576.18.40	40	B18	17,78	17
1576.16.50	50	B16	15,73	20
1576.18.50	50	B18	17,78	20

* **Fino ad esaurimento scorte**
Subject to the selling out
Bis zum restlosen Ausverkauf der Ware
Jusqu'à épuisement du stock
Hasta el final de existencias almacén

BARRE A STELO TENERO

BLANK TOOL-HOLDER

ROHLINGE ZUR BEARBEITUNG VON SONDERAUSFÜHRUNGEN

BARRES D'ALEPAGE SEMI-FINIES

BARRAS CON MANGO BLANDO

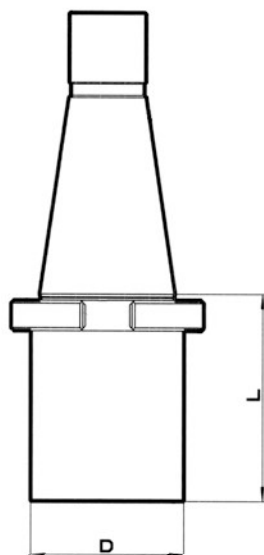

DIN 2080

CODICE CODE BESTELL NR CODE CÓDIGO	ATTACCO SHANK AUFNAHMEN ATTACHEMENT MANGO	D	L
1606.40.40	40	40	160
1606.63.40	40	63	160
1606.80.50	50	80	200